

POINT TYP-30

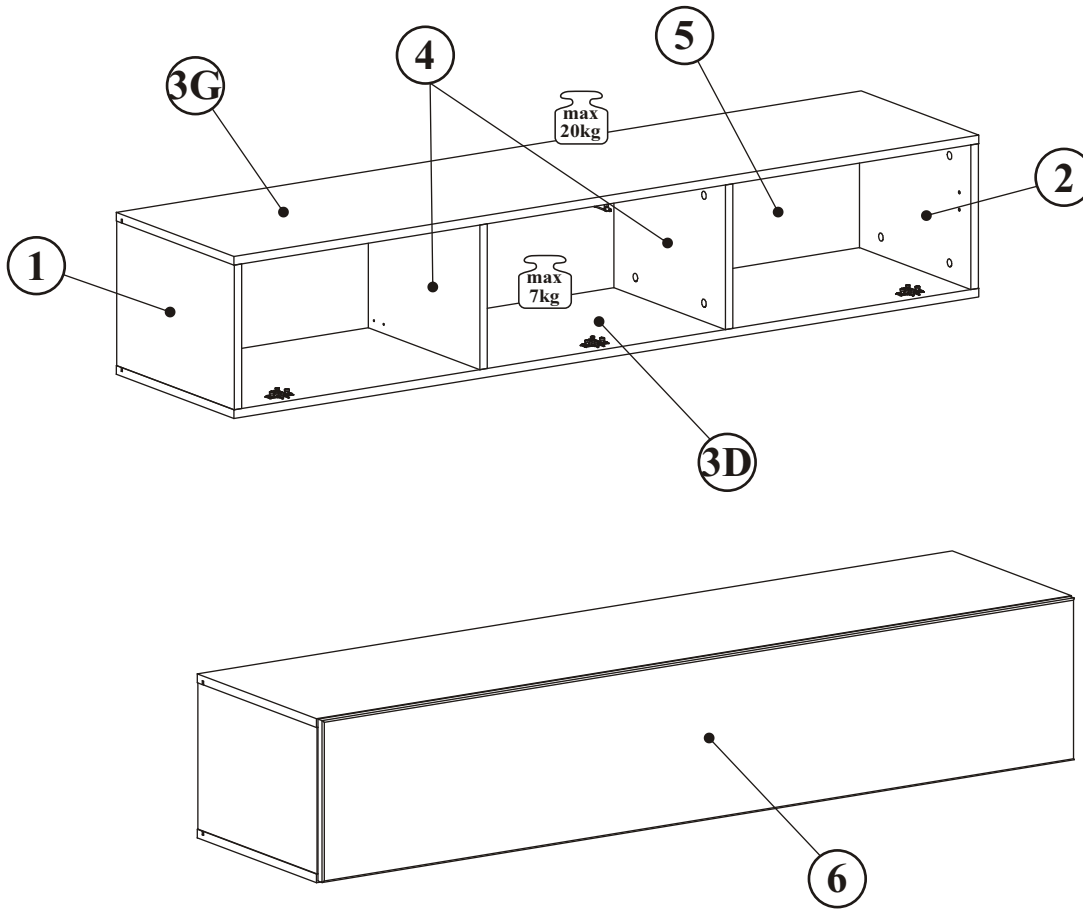

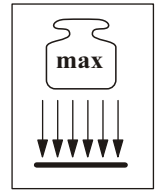

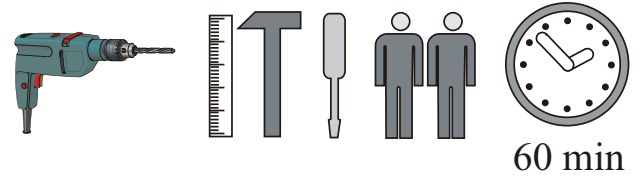





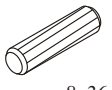
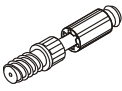

NO	Dim.		Col.-No	Qty
1	268	384	1	1
2	268	384	1	1
3 D/G	1602	384	1	2
4	268	364	1	2
5	1580	280	1	1
6	1596	296	1	1

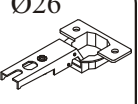
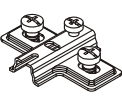
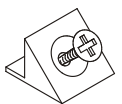

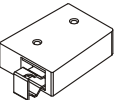
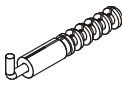

60 min

POINT TYP-30

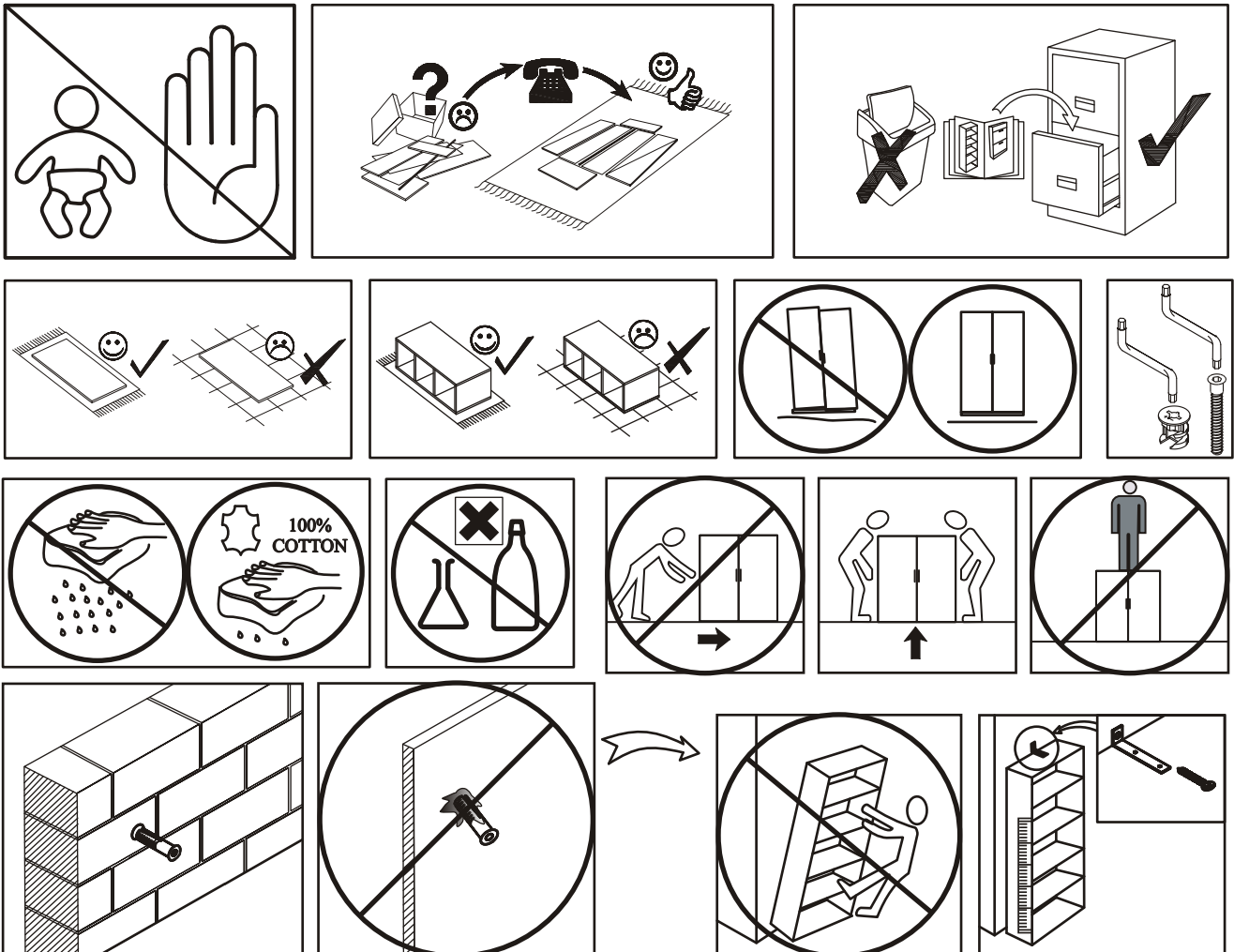
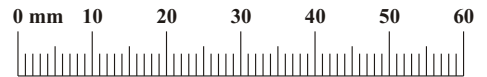
A1 x16  ø8x36	B4 x16 	B5 x16  ø15x12	G5 x16 	D7 x6  USØ3x16	G2 x1 
E1 x3  H=0	E2 x3  H=0	S1 x12 	D6 x8  USØ3,5x30	D10 x12  USØ3,5x13	G21 x2 
ZR1 x4 	KR2 x4 	T1 x1 			

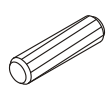

POINT TYP-30

A1		B5	
x16	ø8x36	x16	ø15x12

1

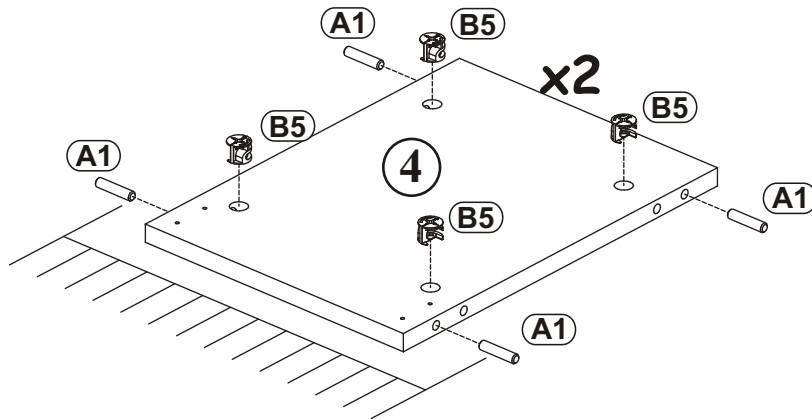
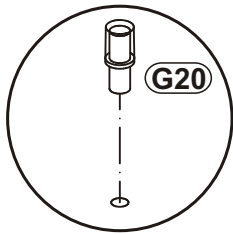
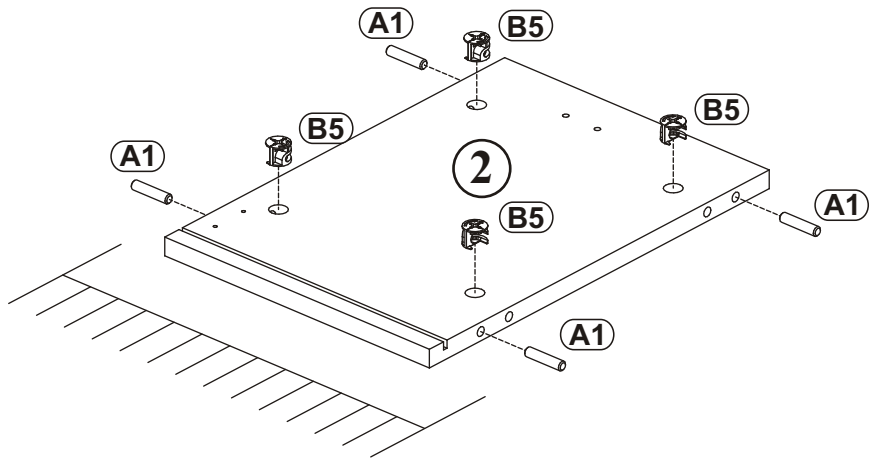
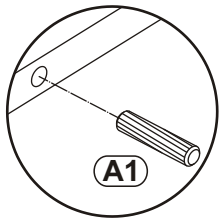
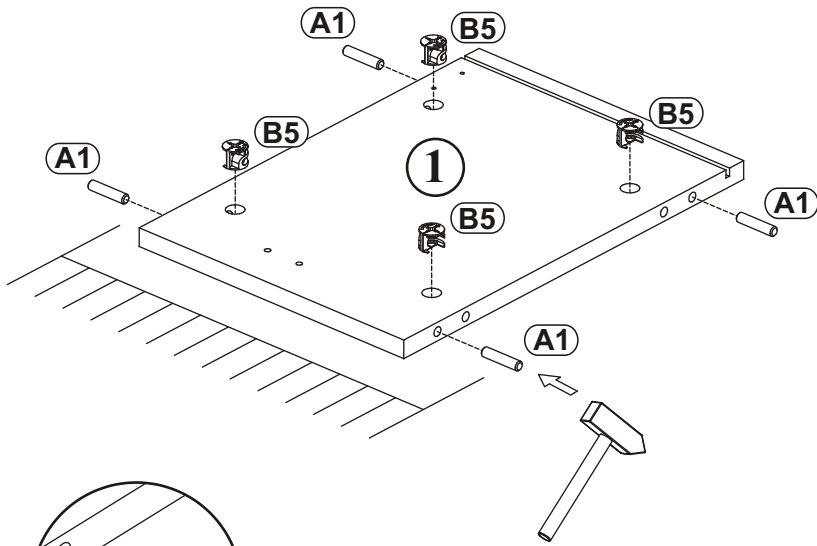

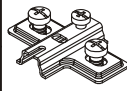
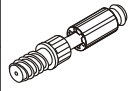

POINT TYP-30

2

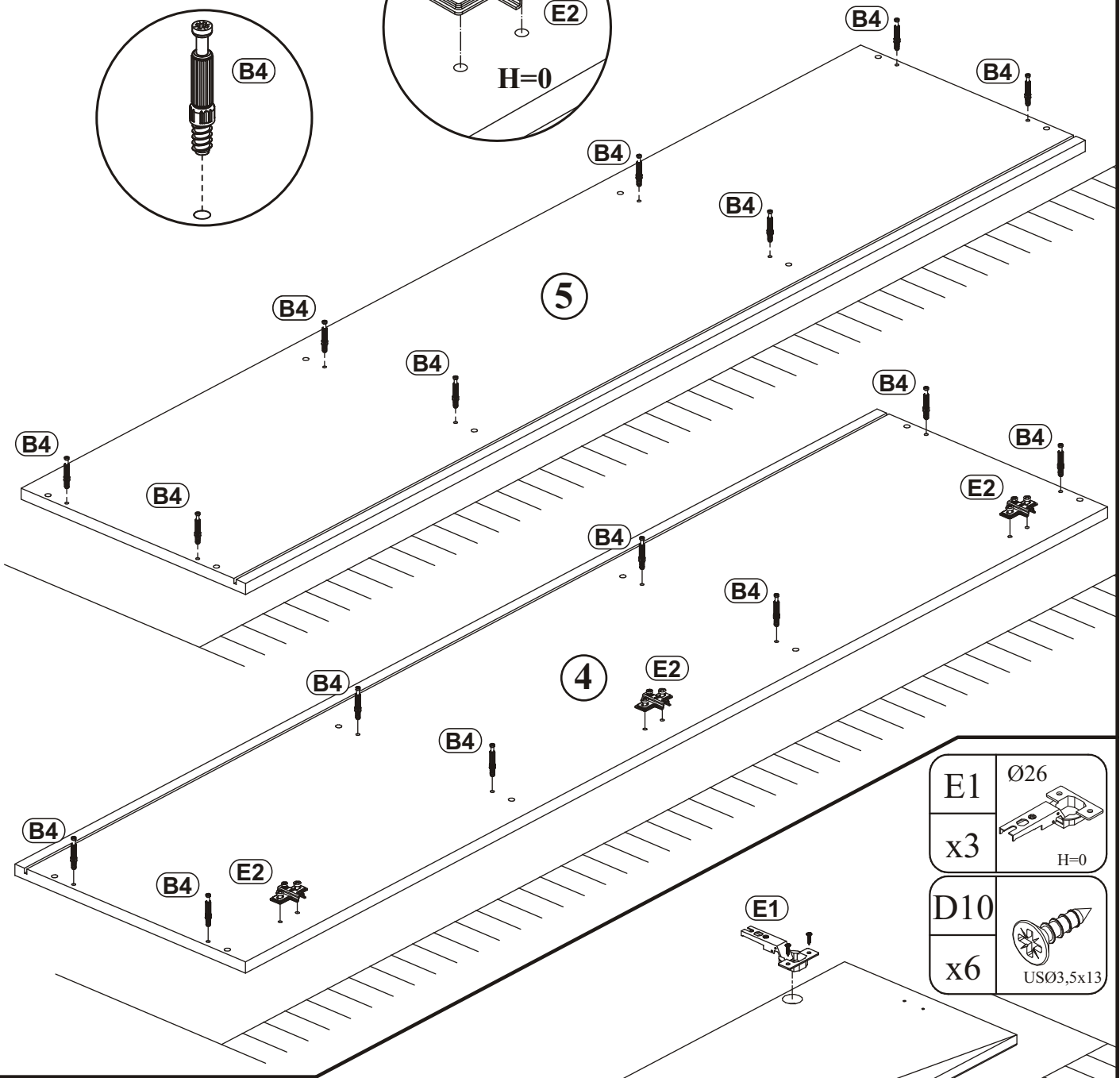
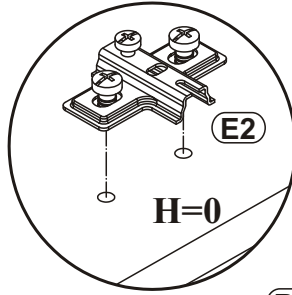
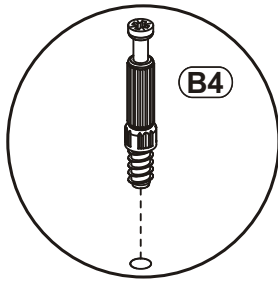
E2		B4	
x3	H=0	x16	

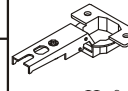

3

E1		Ø26
x3	H=0	
D10		
x6	USØ3,5x13	

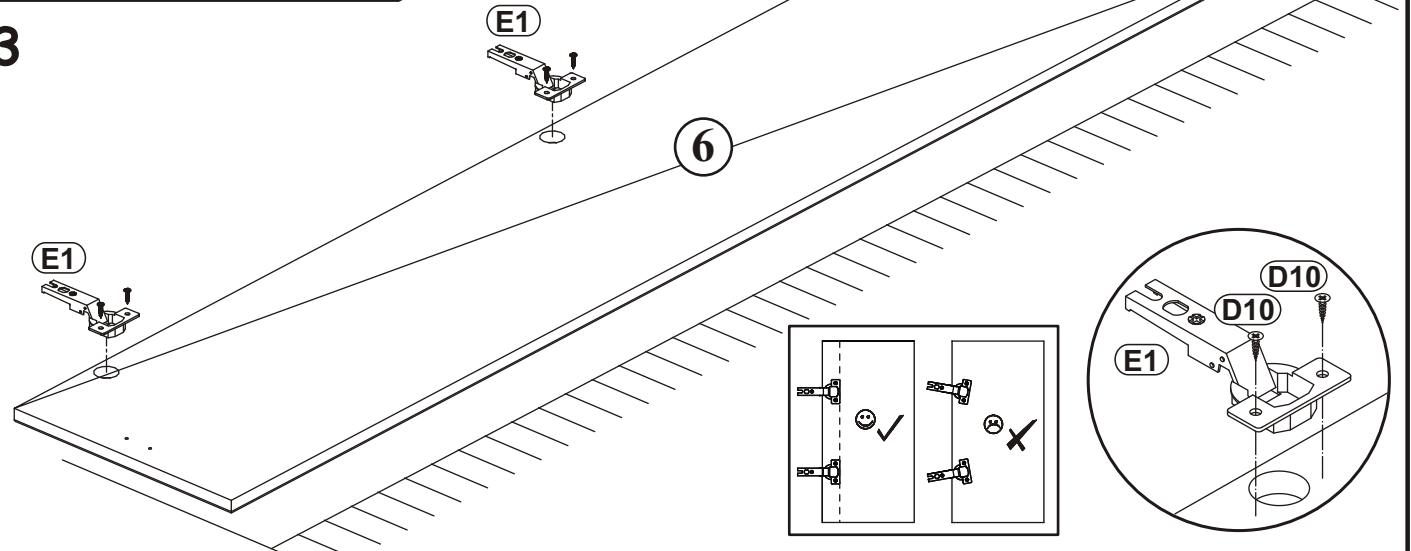

G5	
x16	

4

a)

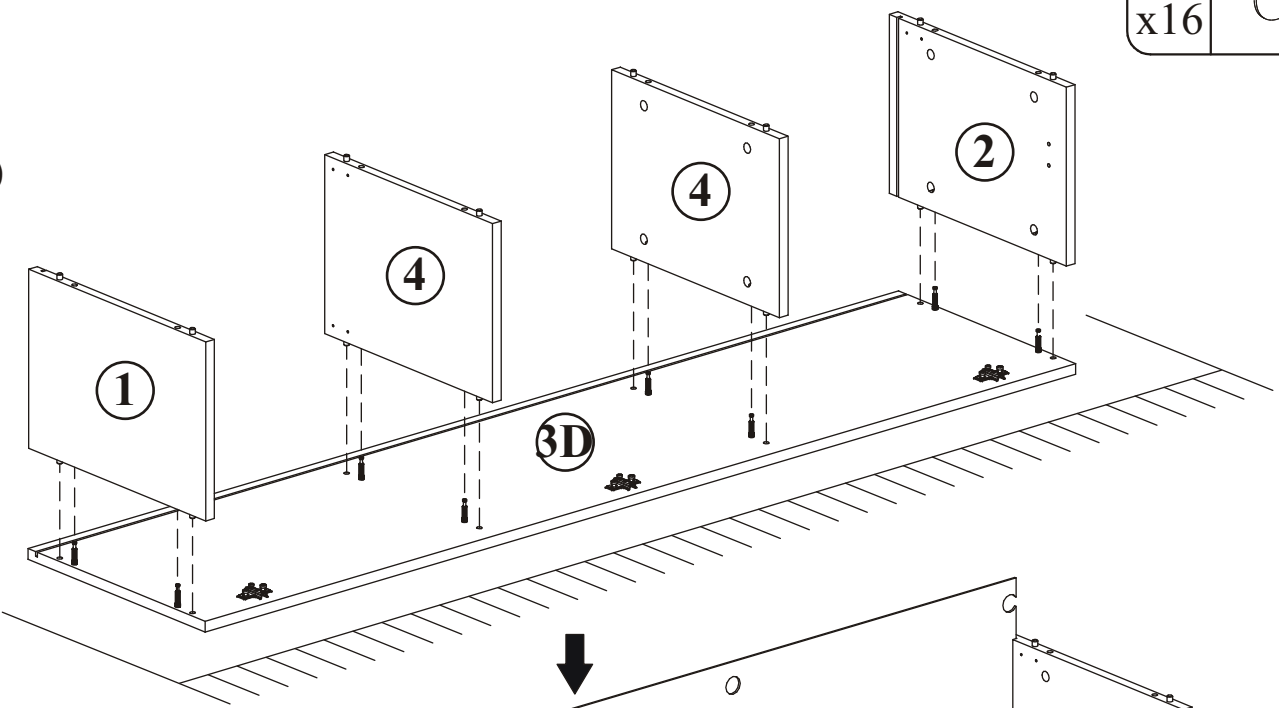

b)

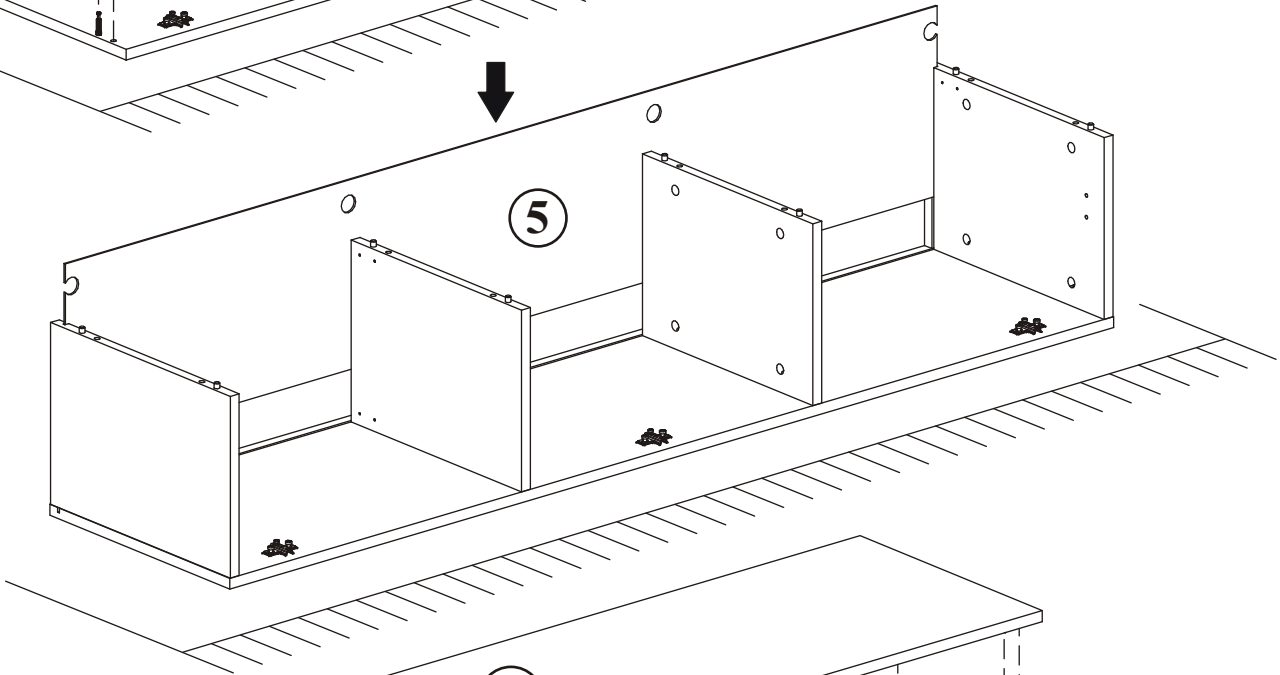

c)

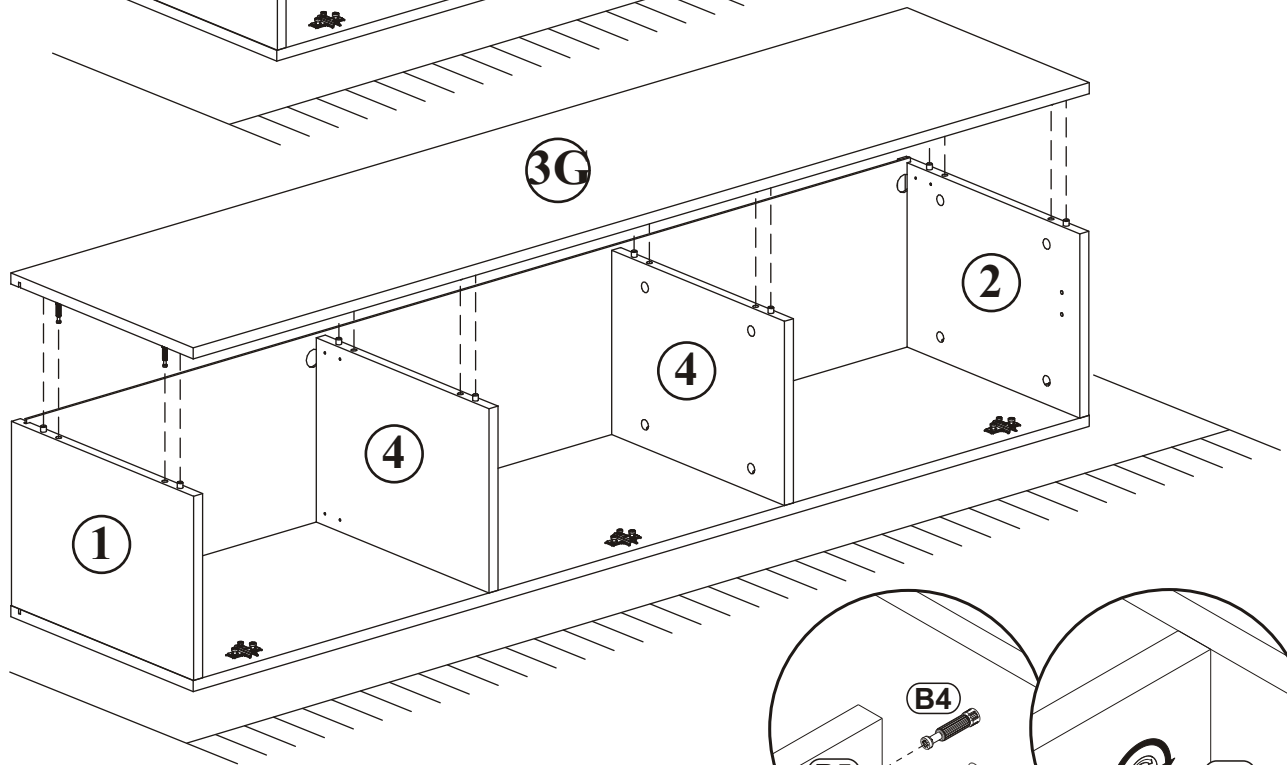

POINT TYP-30

5



S1	
x12	

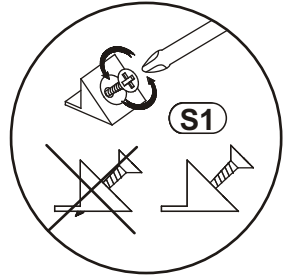
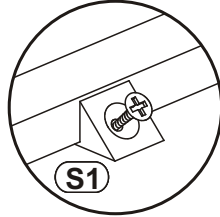
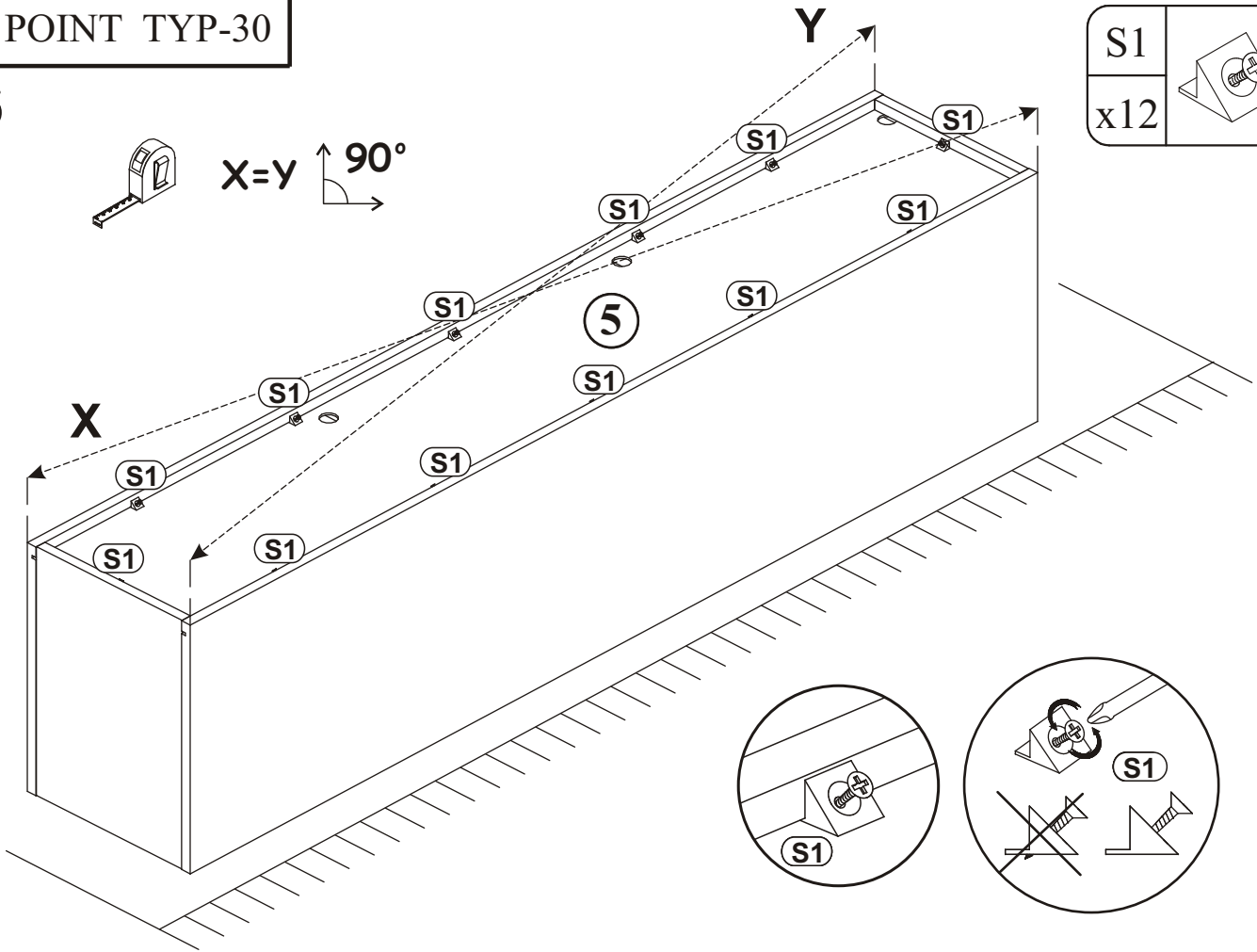

6

ZR1	
x4	

D6	
x8	USØ3,5x30

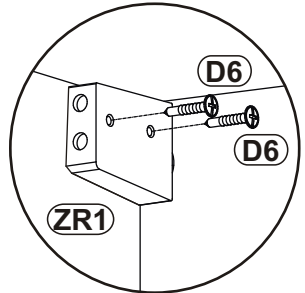
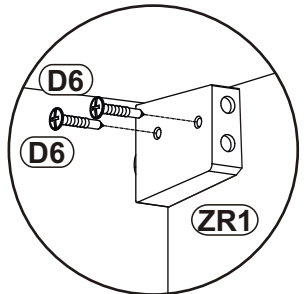
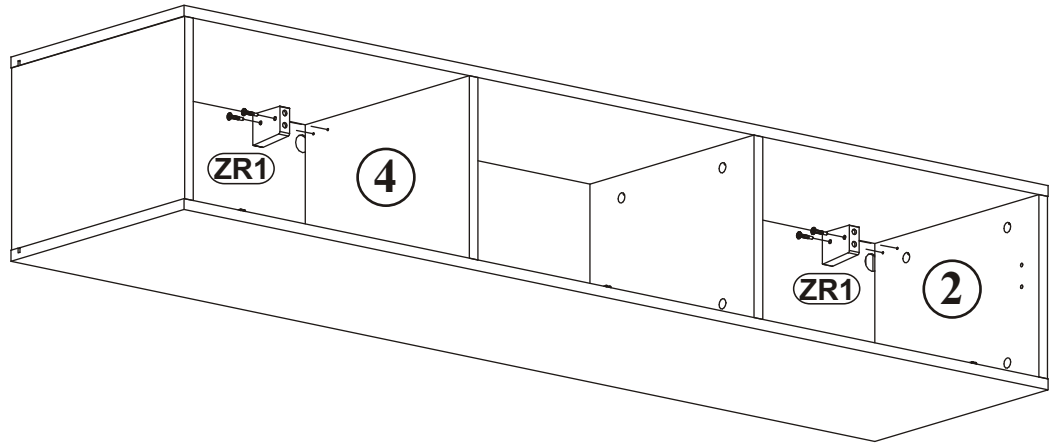
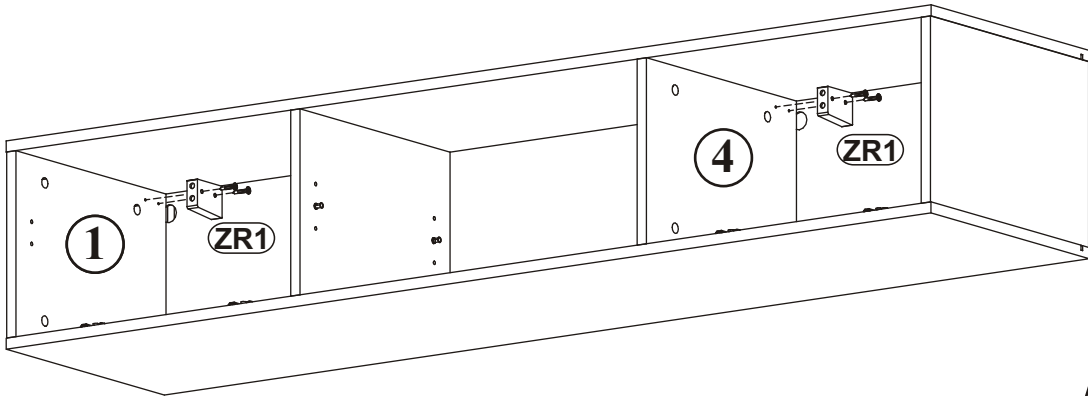

POINT TYP-30

7

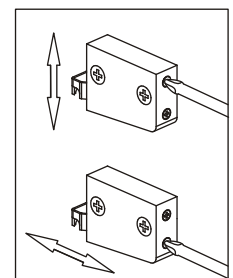
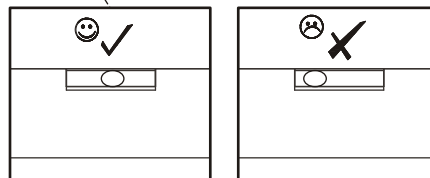
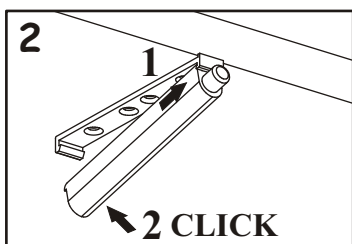
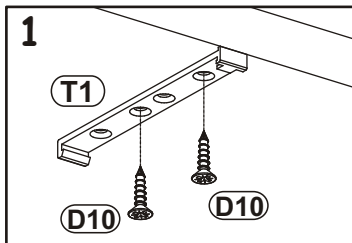
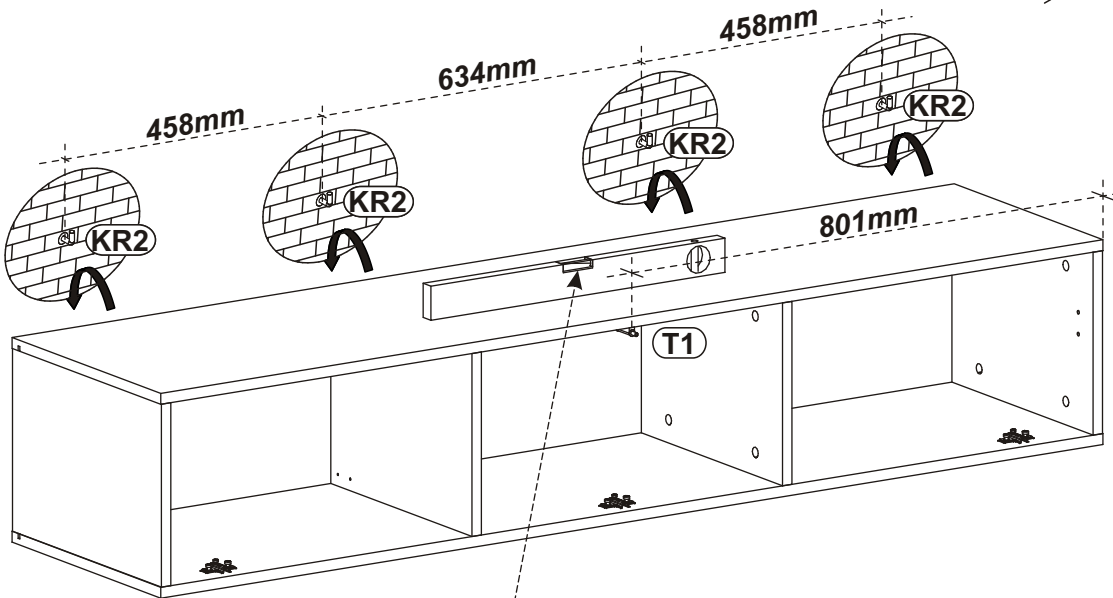
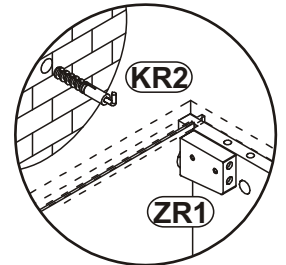
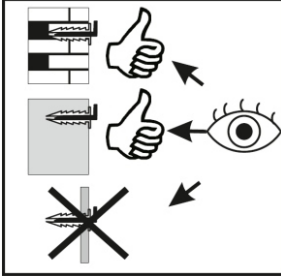
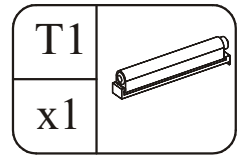
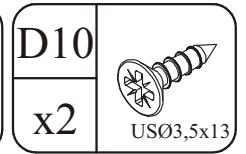
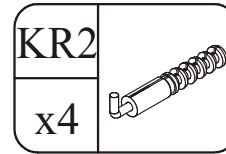

8

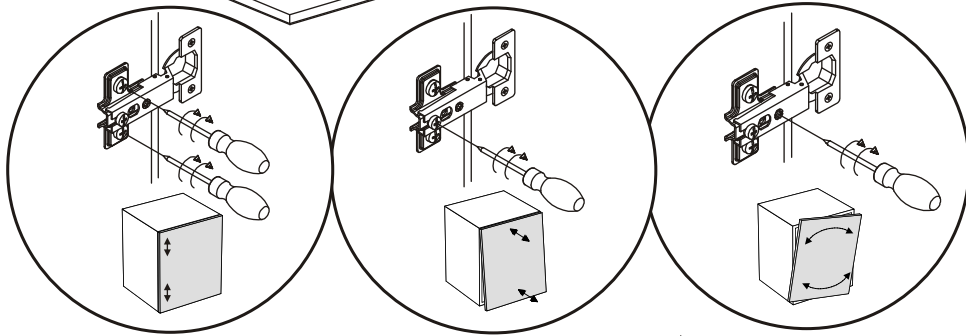
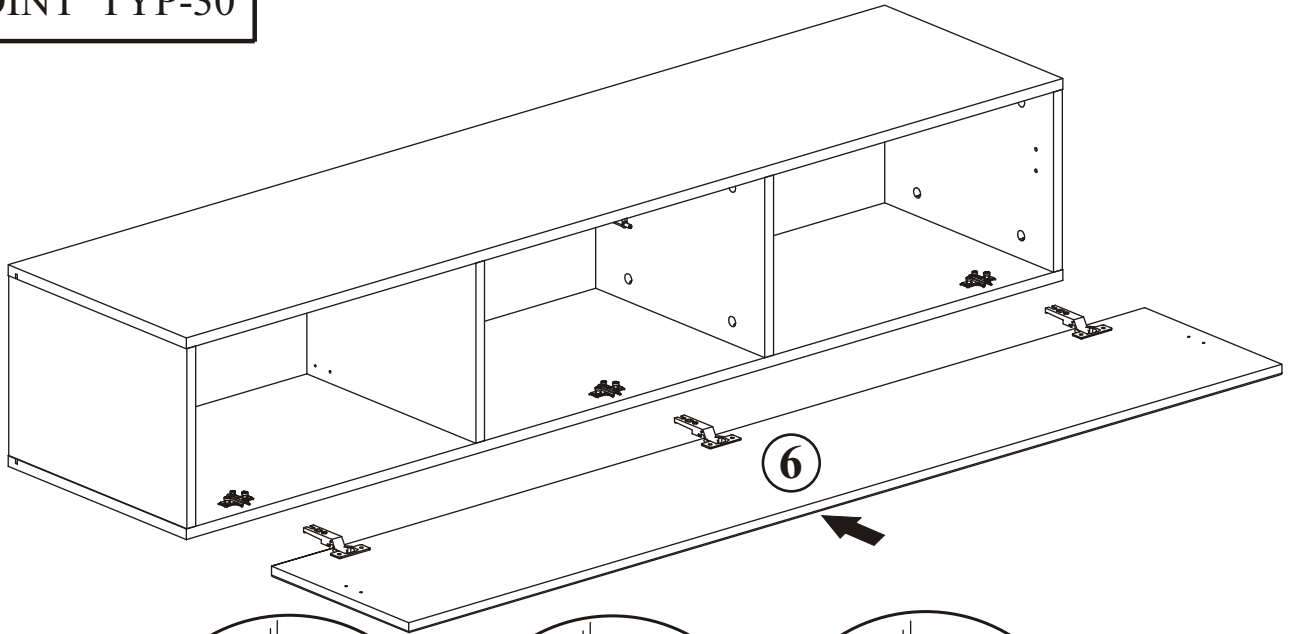

9

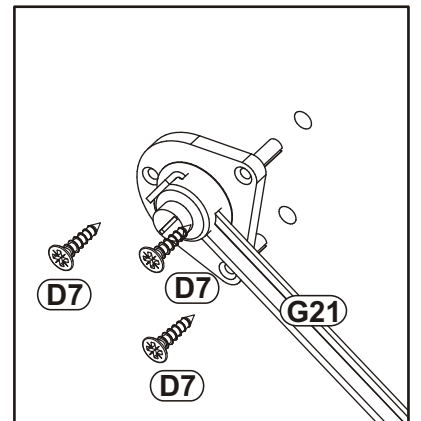
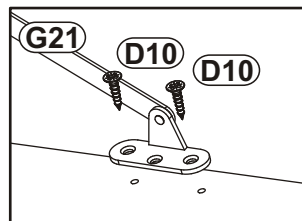
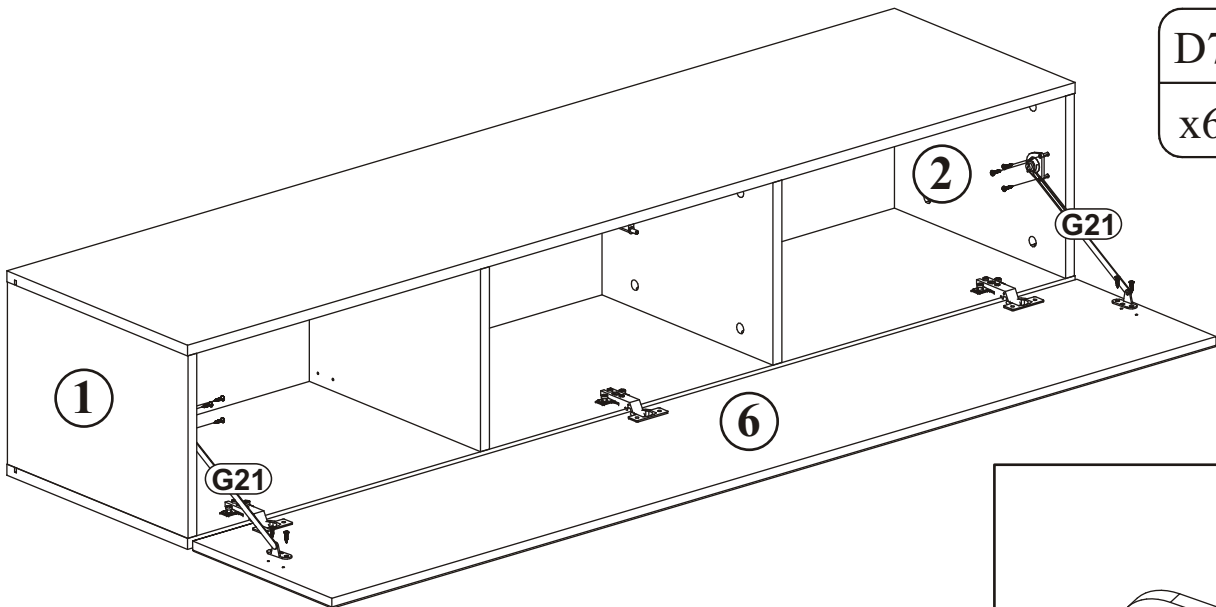
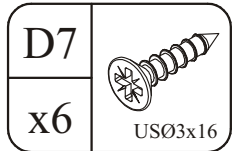
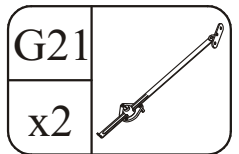
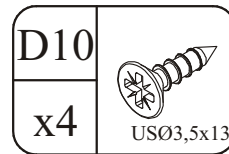

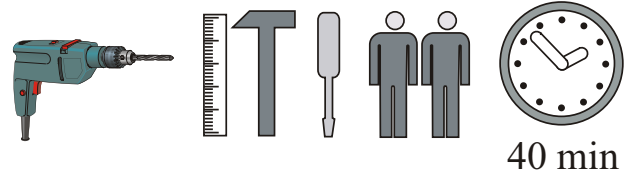
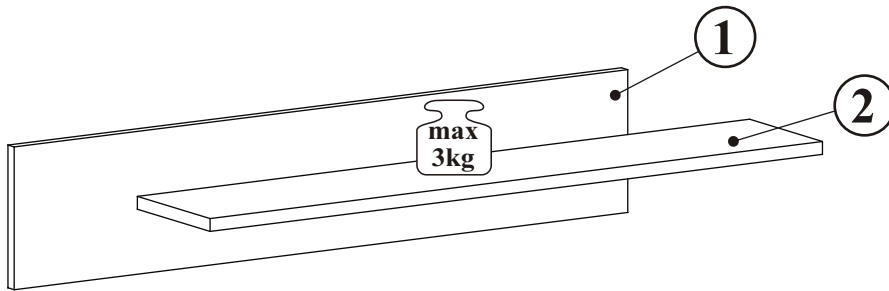
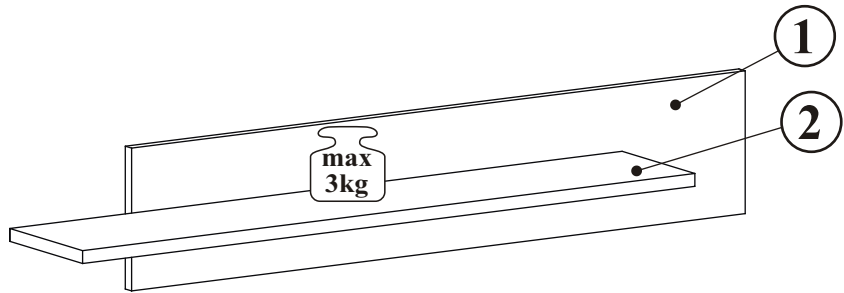
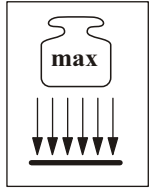
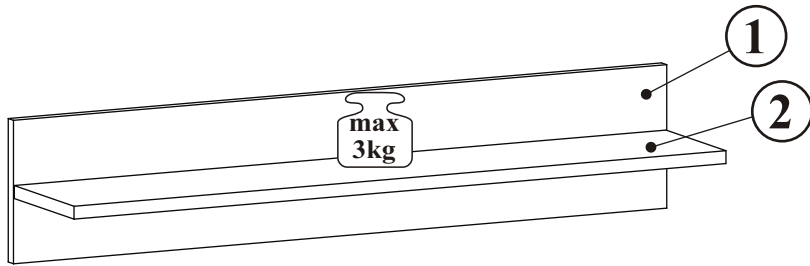

POINT 23_MX

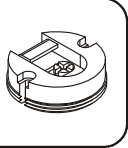
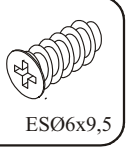

NO	Dim.		Col.-No	Qty
1	1002	200	1	2
2	1000	185	1	2

POINT 23_MX

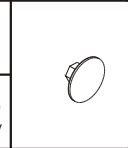
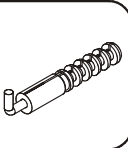
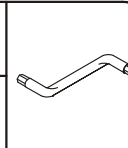
ZM1 x4		D20 x8	 ESØ6x9,5	B11 x12	 Ø7x50	G4 x12		KR2 x4		G2 x1	
-----------	---	-----------	---	------------	--	-----------	--	-----------	---	----------	---

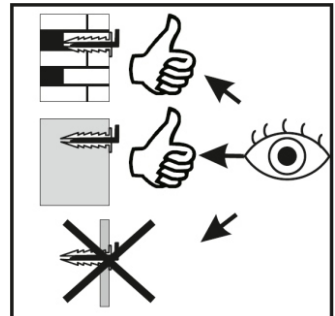
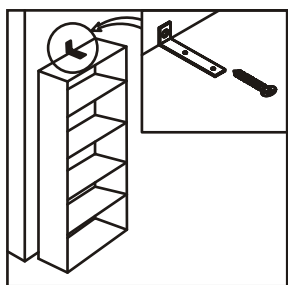
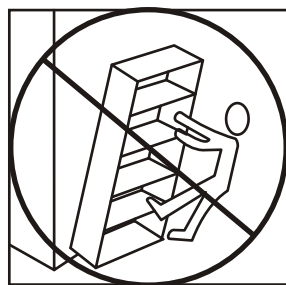
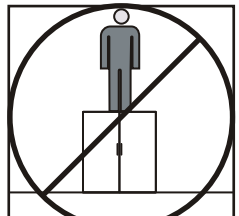
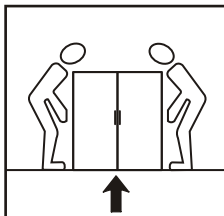
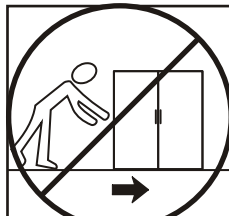
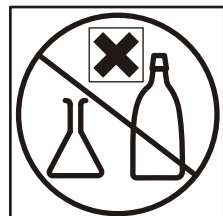
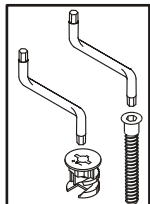
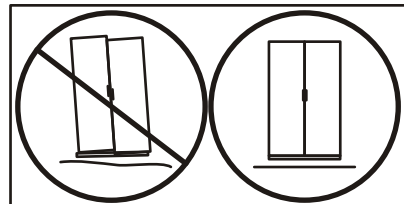
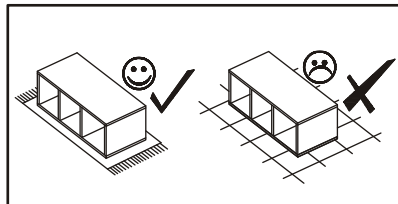
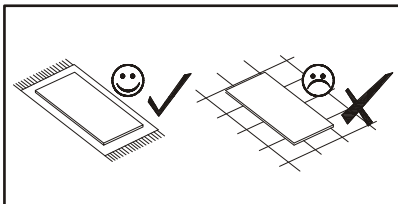
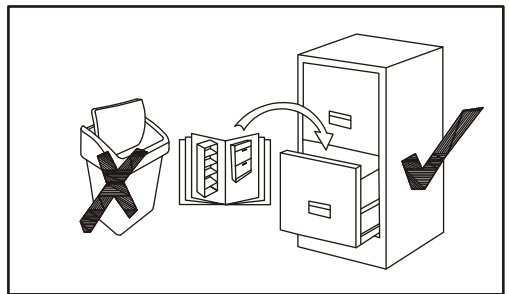
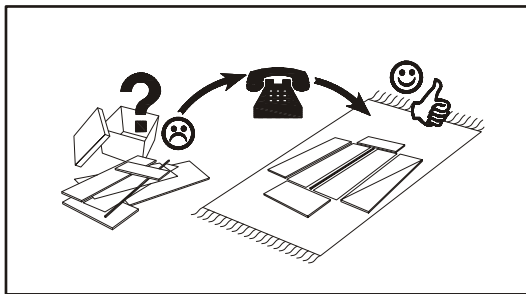
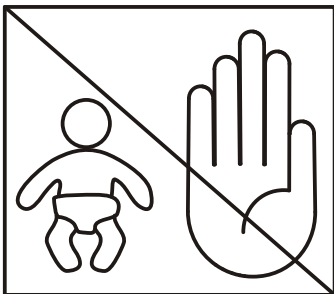
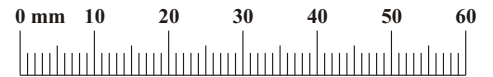

1-3

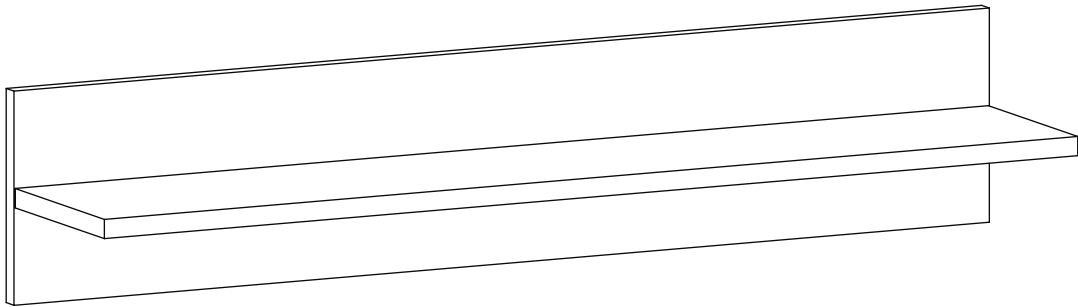

4-6

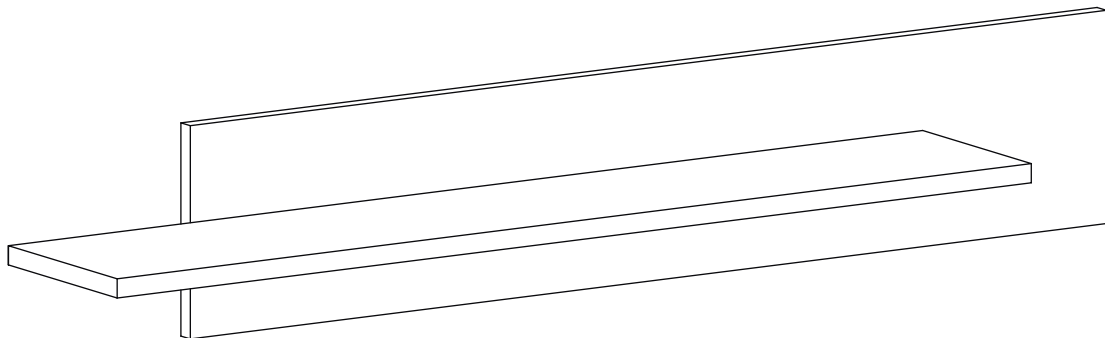

7-9

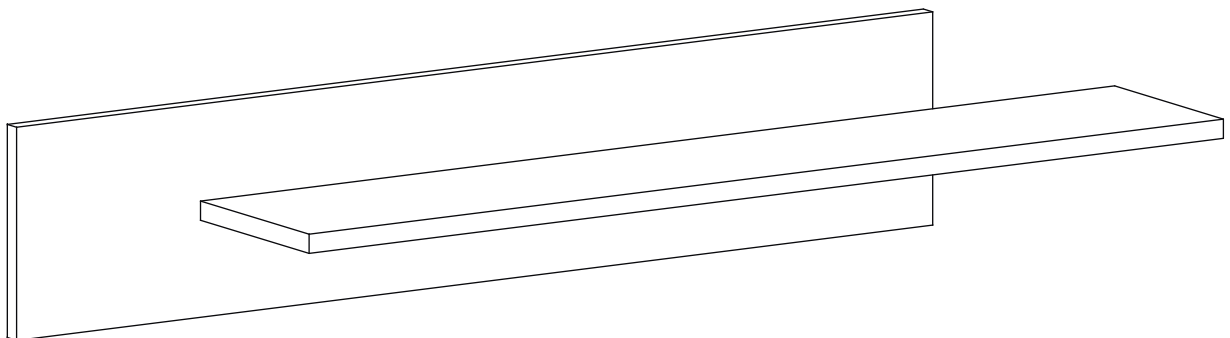

POINT 23_MX

1

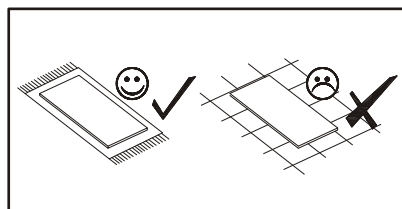

ZM1
x4

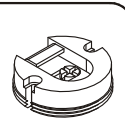

D20
x8



ESØ6x9,5

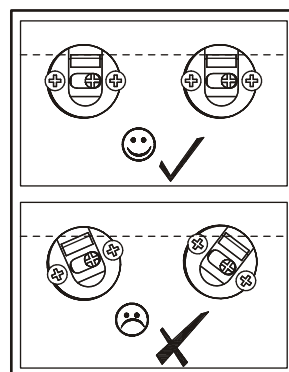
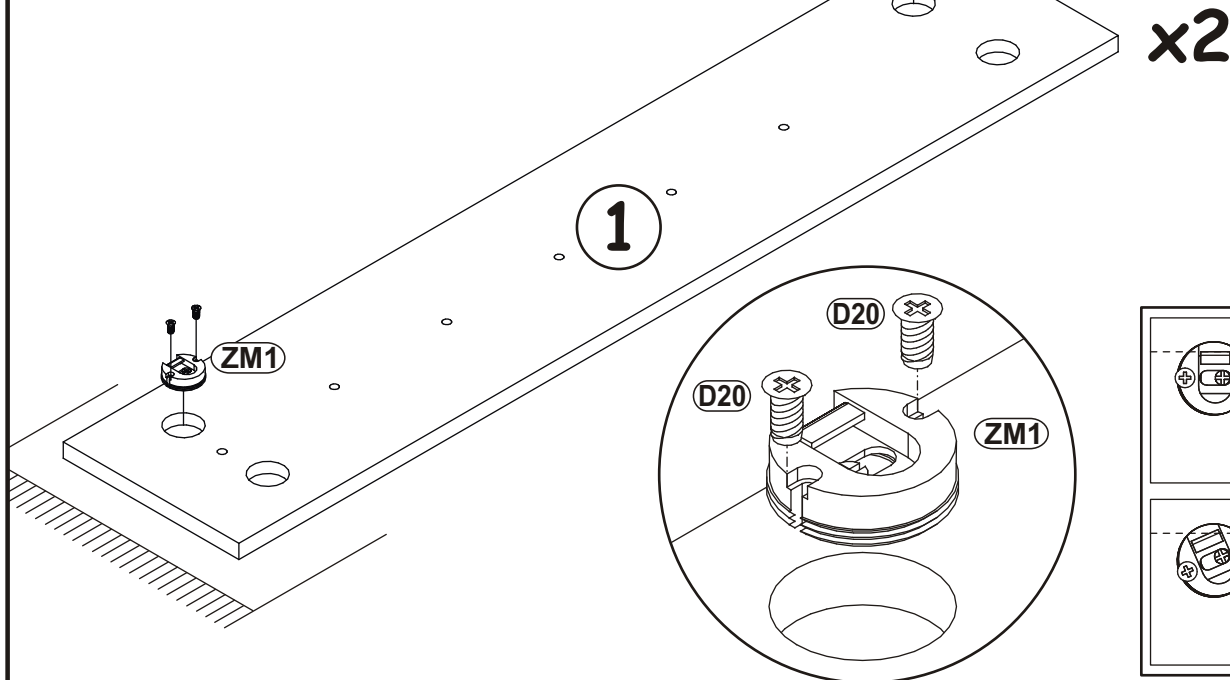

2

B11
x12

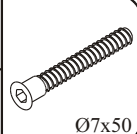

Ø7x50

G4
x12

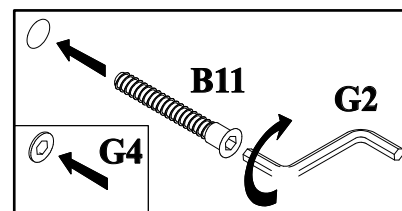
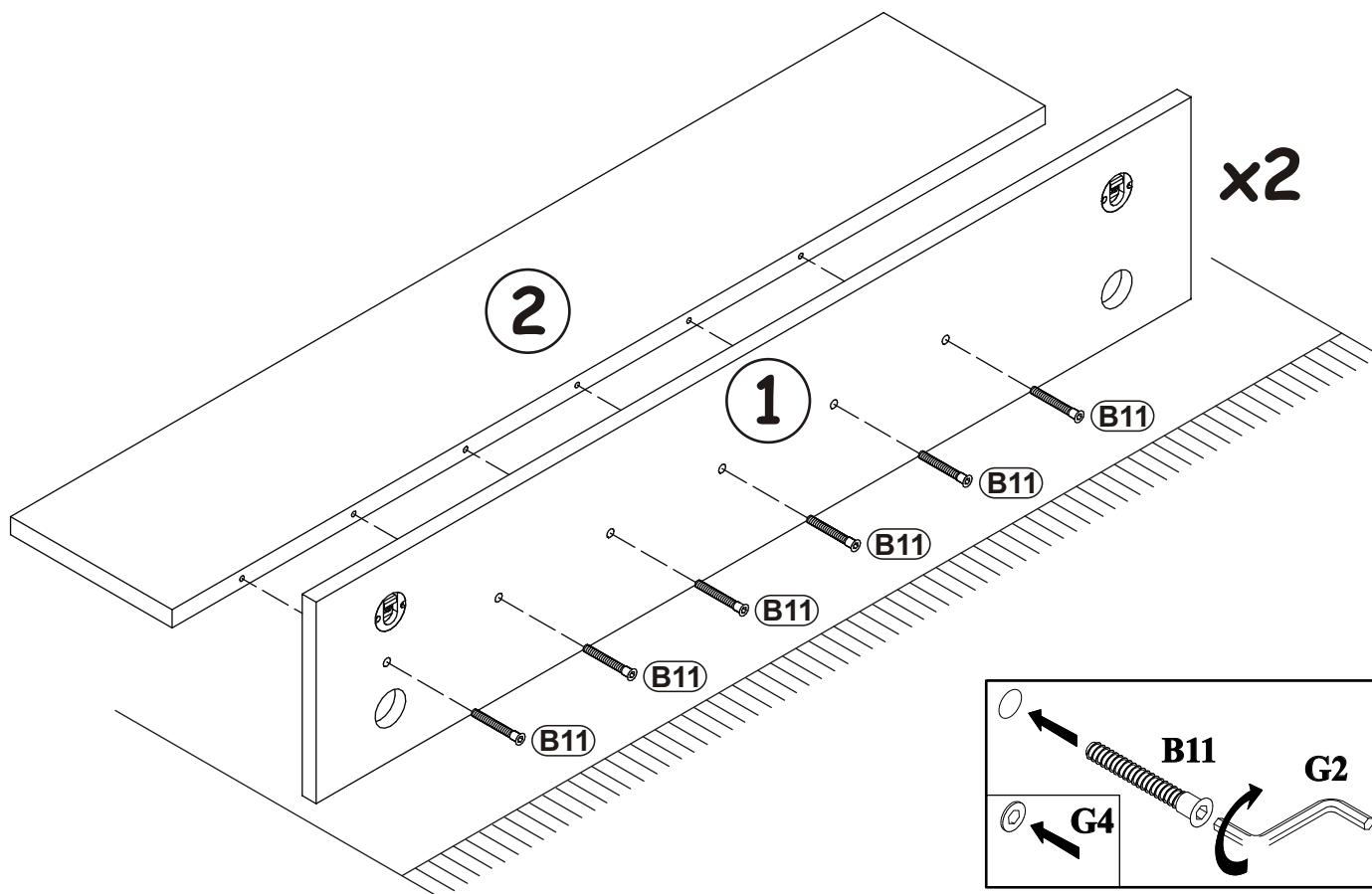

3

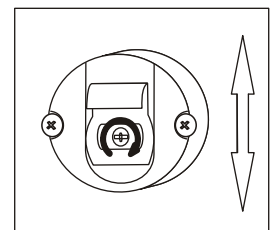
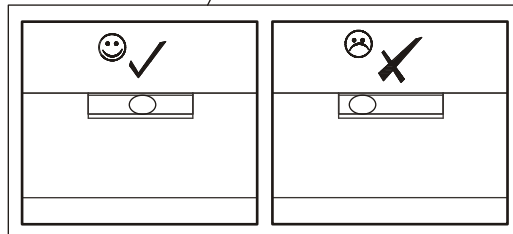
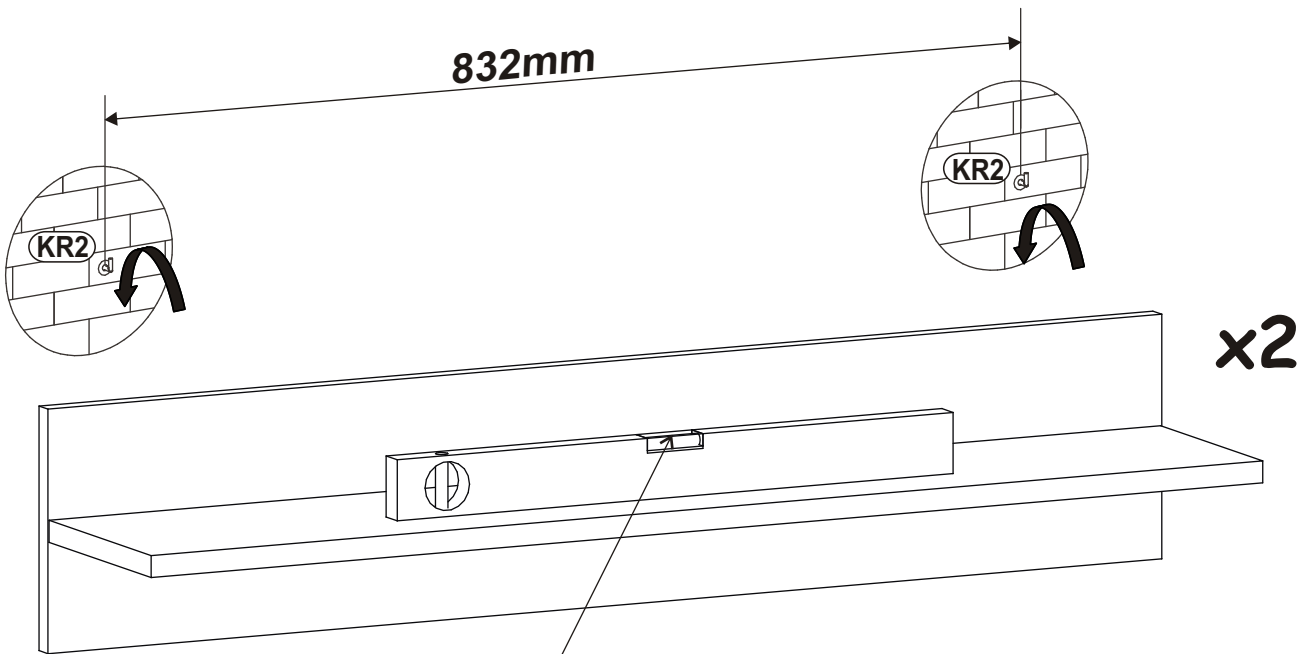
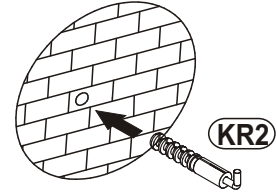
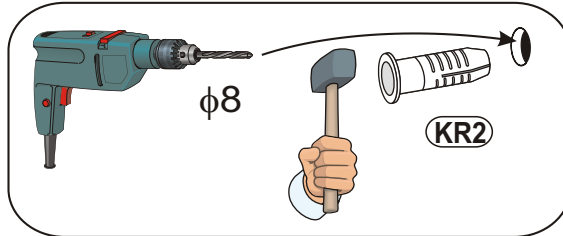
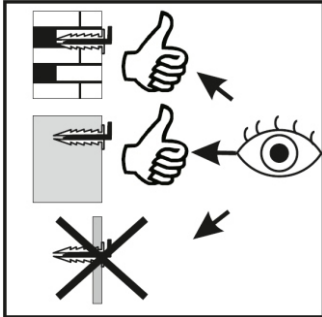
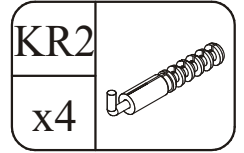

POINT 23_MX

4

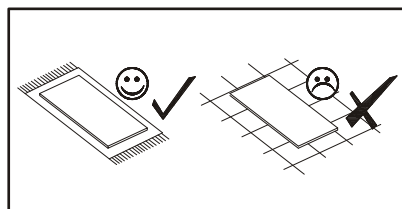

ZM1	
x4	

D20	
x8	ES06x9,5

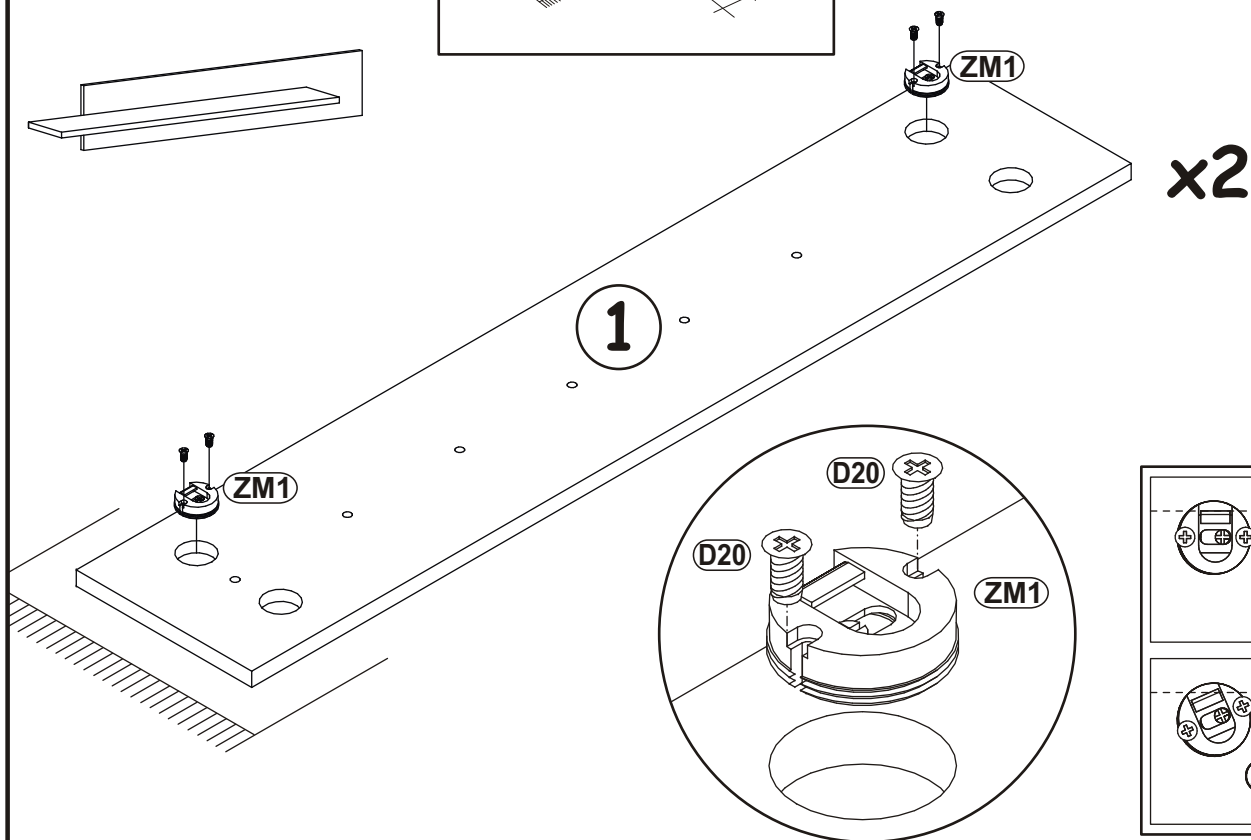

5

B11	
x12	Ø7x50

G4	
x12	

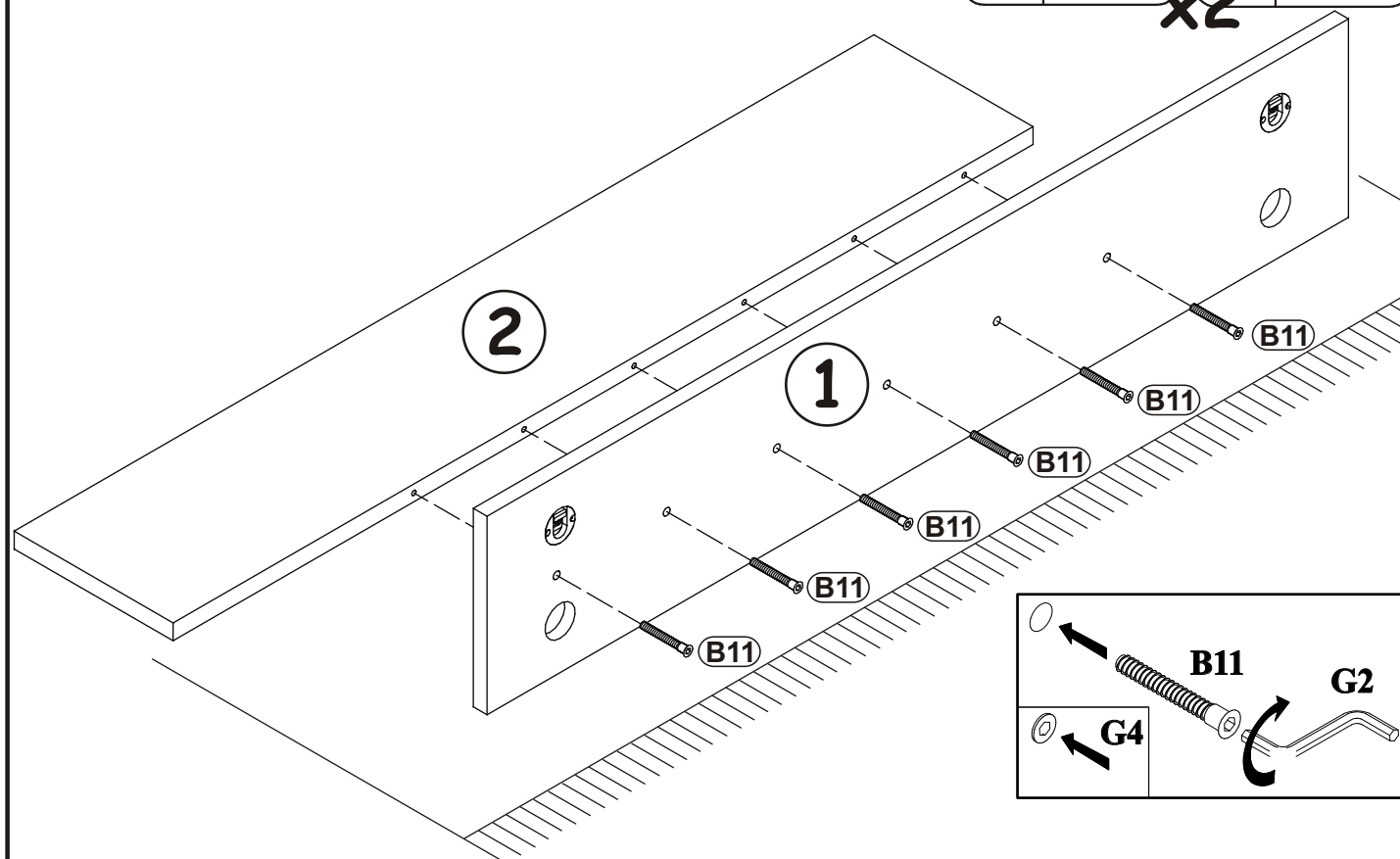

6

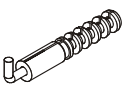
KR2	
x4	

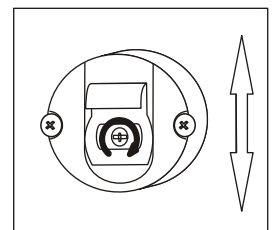
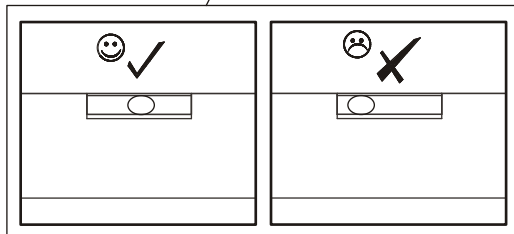
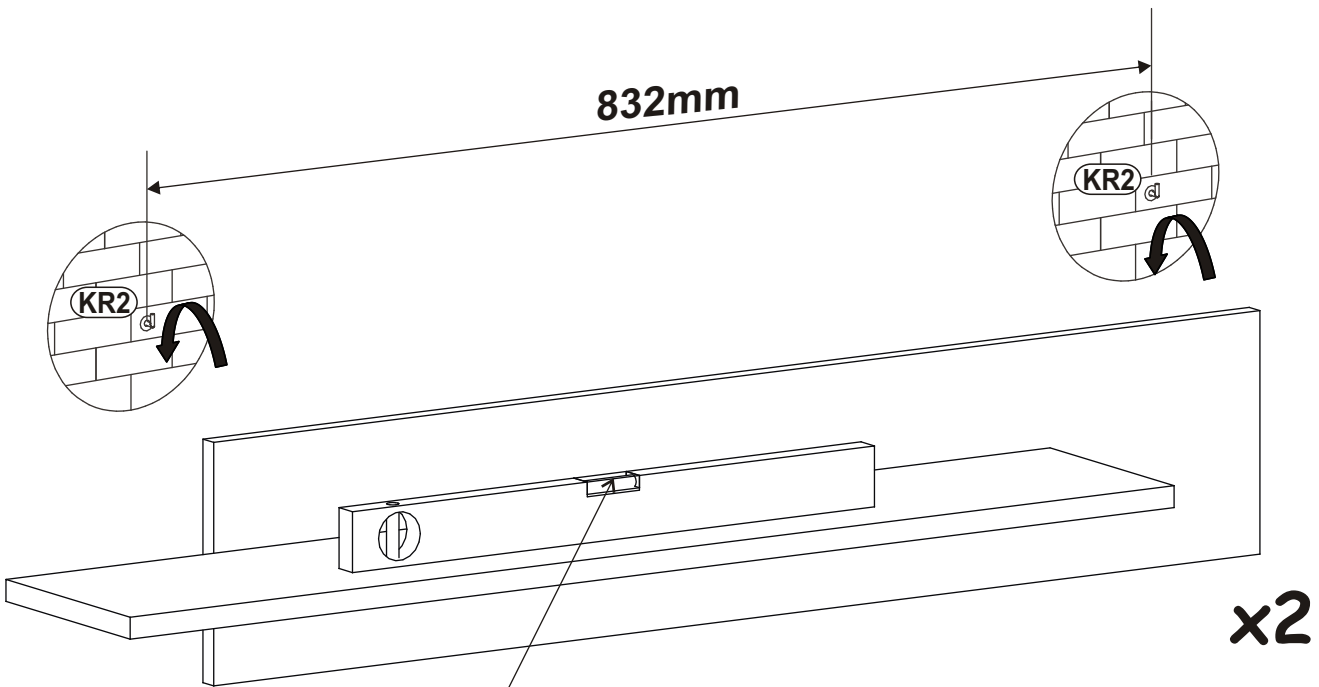
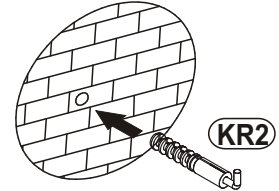
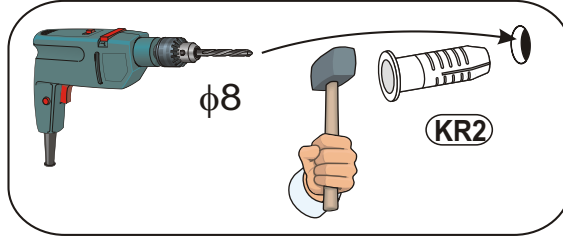
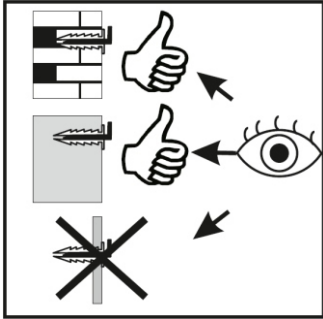
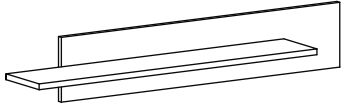

POINT 23_MX

7

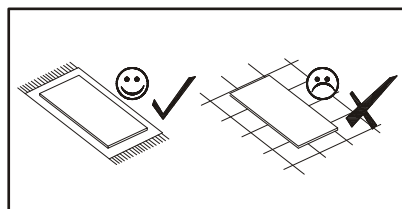

ZM1

x4



D20

x8



ESØ6x9,5

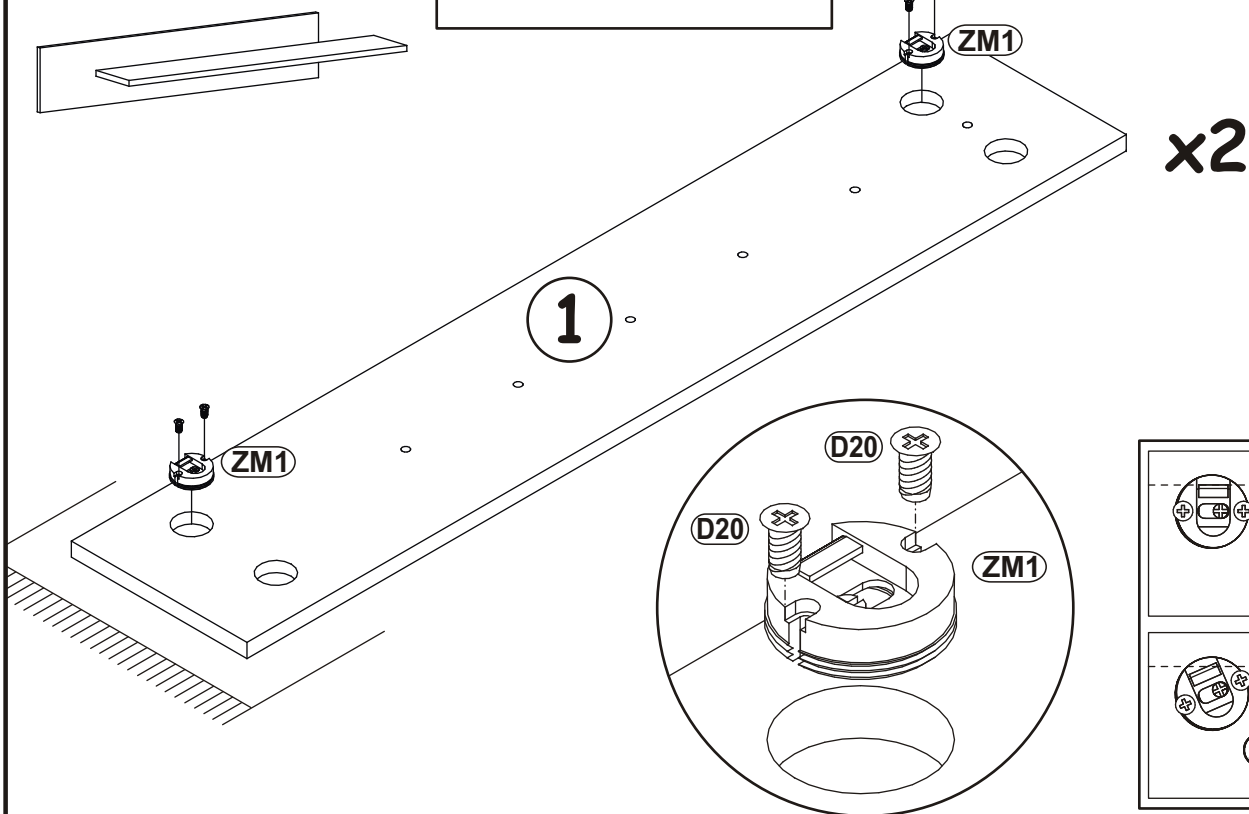

8

B11

x12



Ø7x50

G4

x12

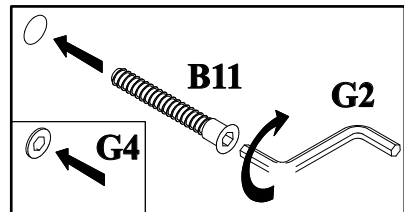
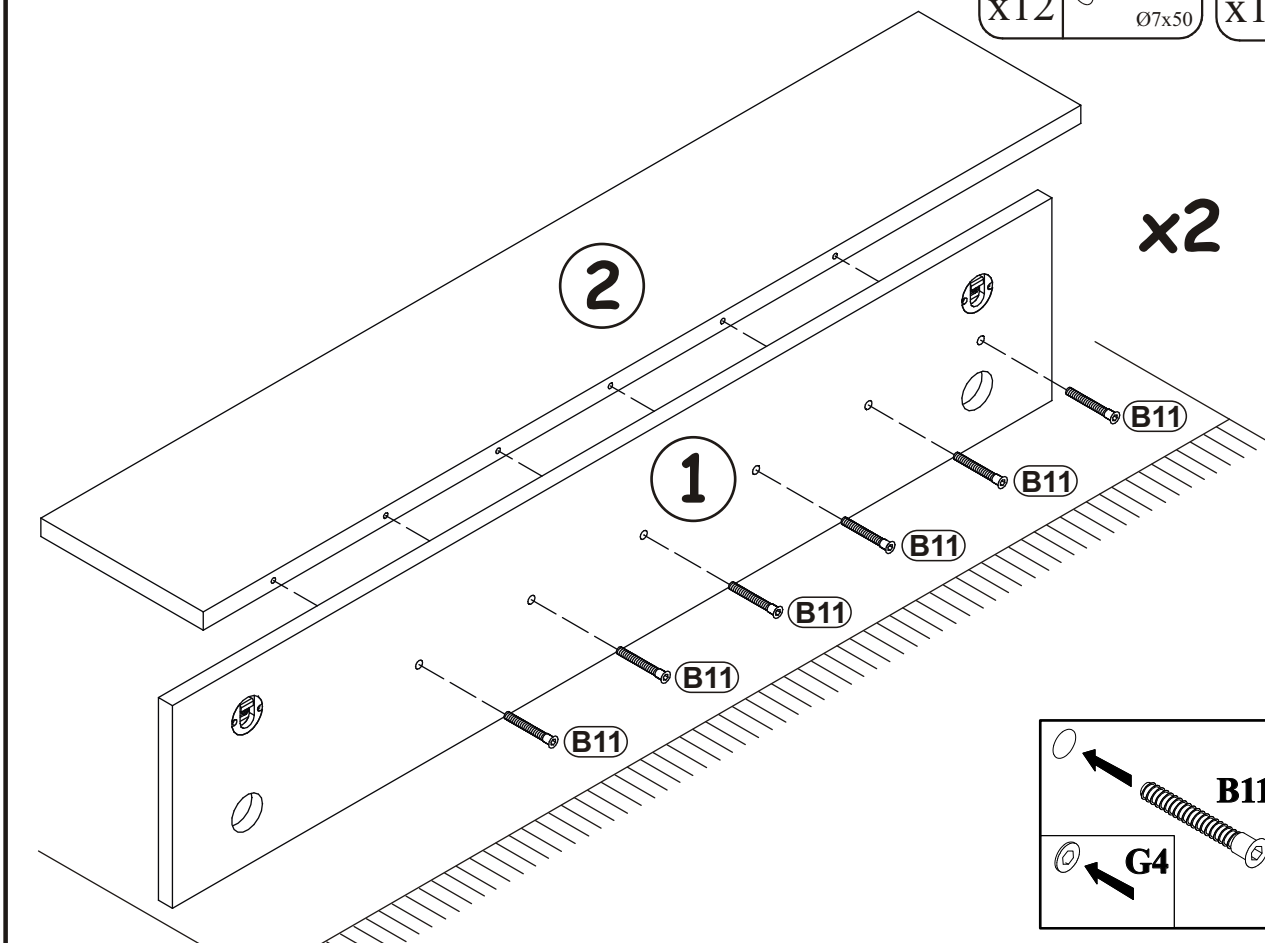

9

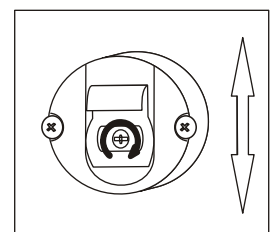
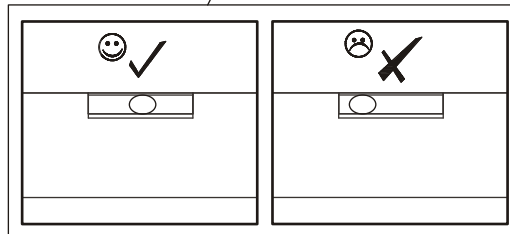
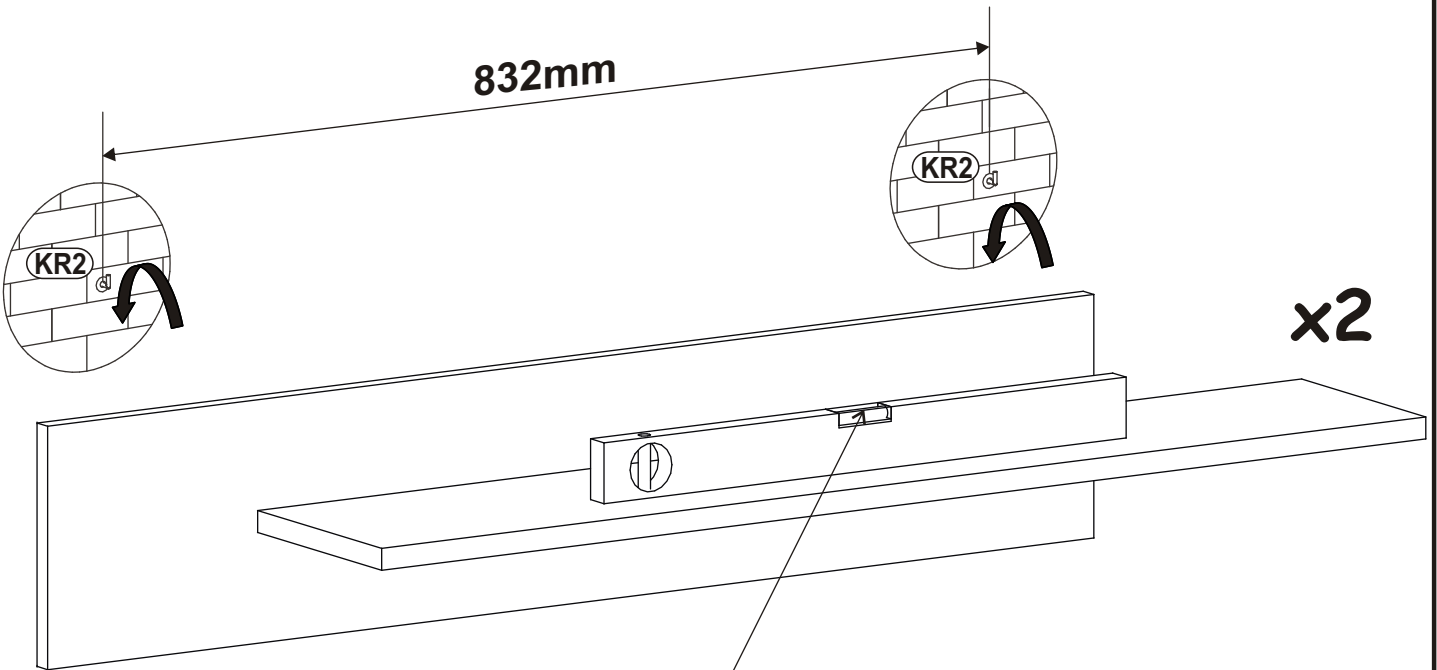
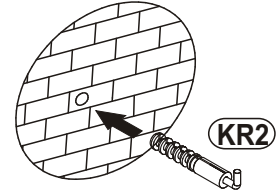
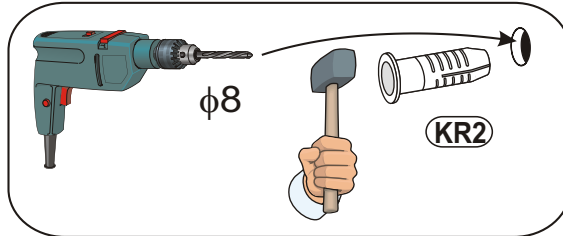
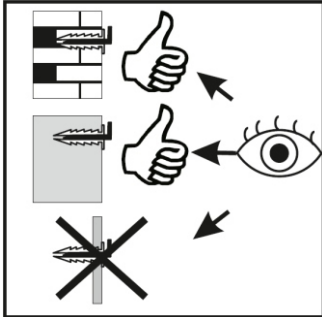
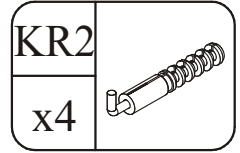

POINT TYP-21

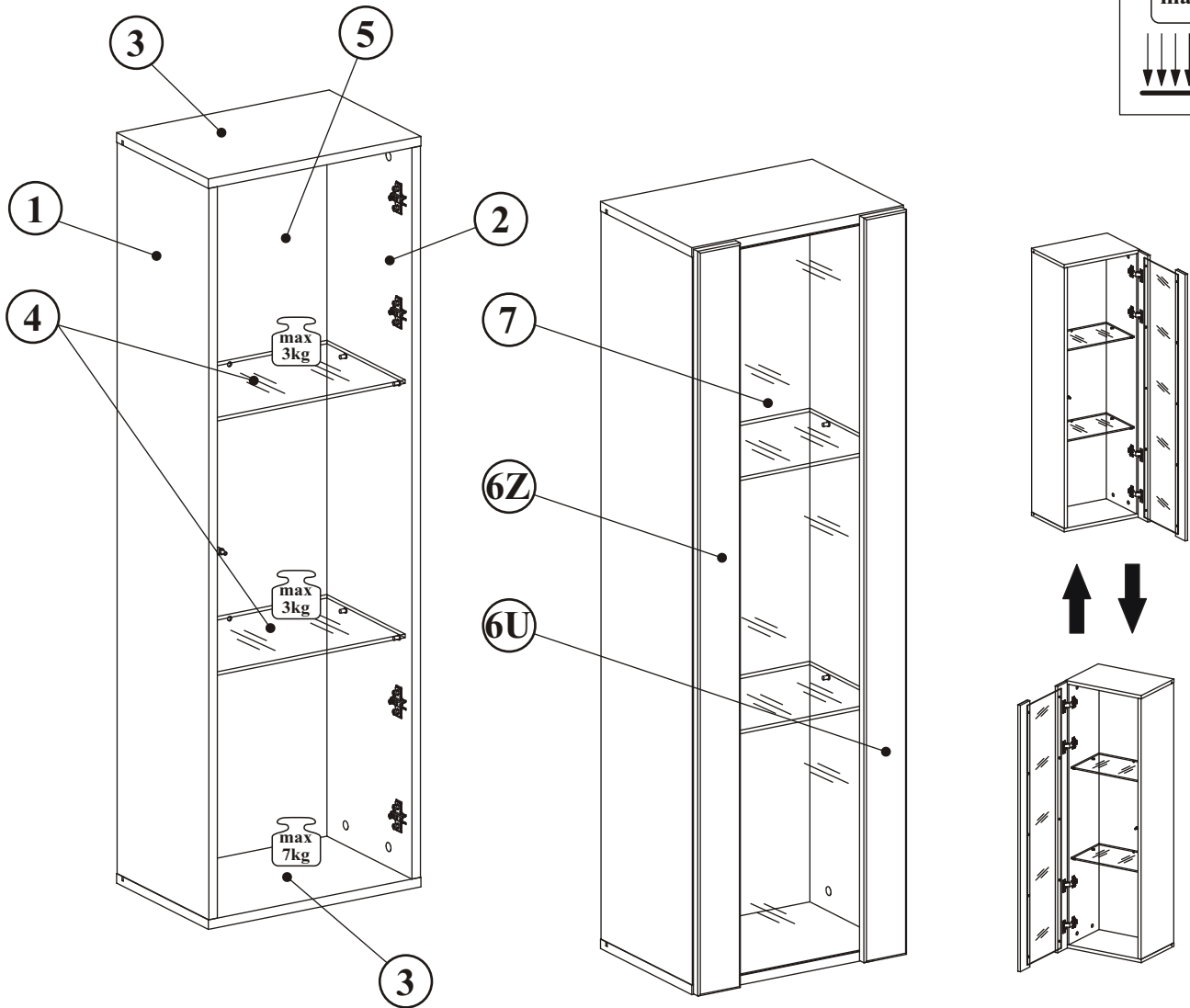



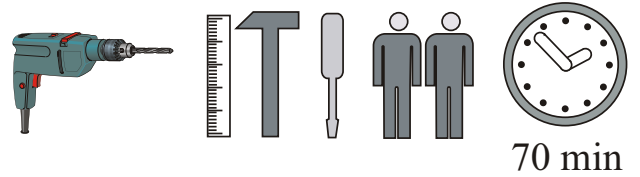





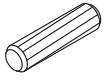
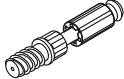
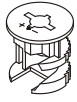

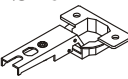
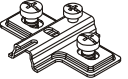
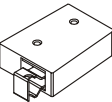
NO	Dim.		Col.-No	Qty
1	1228	274	1	1
2	1228	274	1	1
3	400	274	1	2
4	364	234	1	2
5	1240	378	1	1
6Z	80	1256	1	1
6U	80	1256	1	1
7	1224	283	1	1

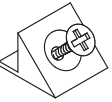

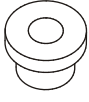
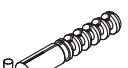
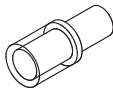
70 min

POINT TYP-21

A1 x8  ø8x36	B4 x8 	B5 x8  ø15x12	G5 x8 	E1 x4  Ø26 H=0	E2 x4  H=0
ZR1 x2 	D6 x4  USØ3,5x30	S1 x10 	D10 x10  USØ3,5x13	UP13 x10  UPØ3x16	P2 x10 
KR2 x2 	G20 x8 	G2 x1 	Z2 x8  Ø5	T1 x1 	

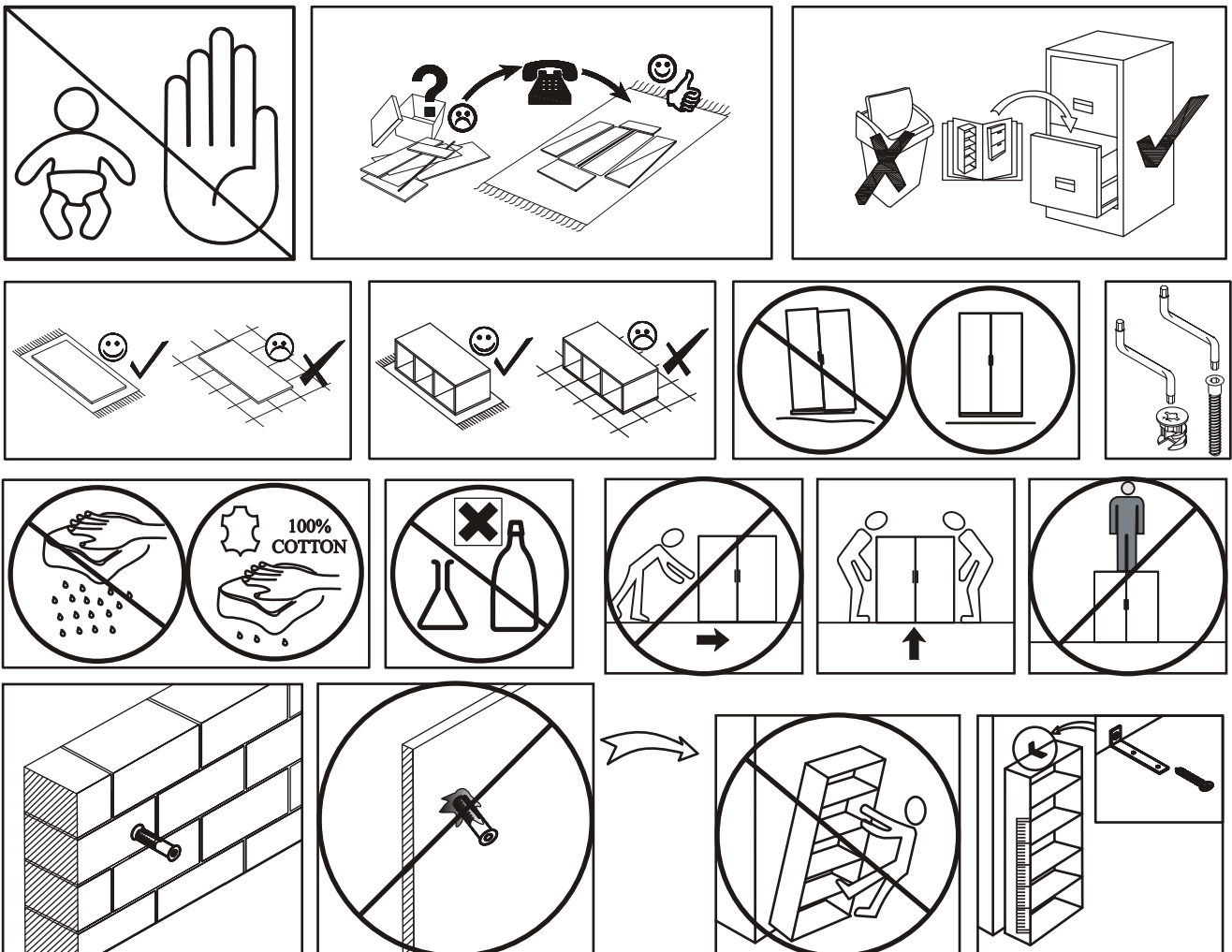

POINT TYP-21

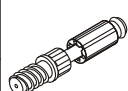
B4	
x8	

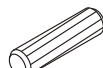
A1	
x8	ø8x36

B5	
x8	ø15x12

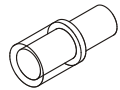
G20	
x8	

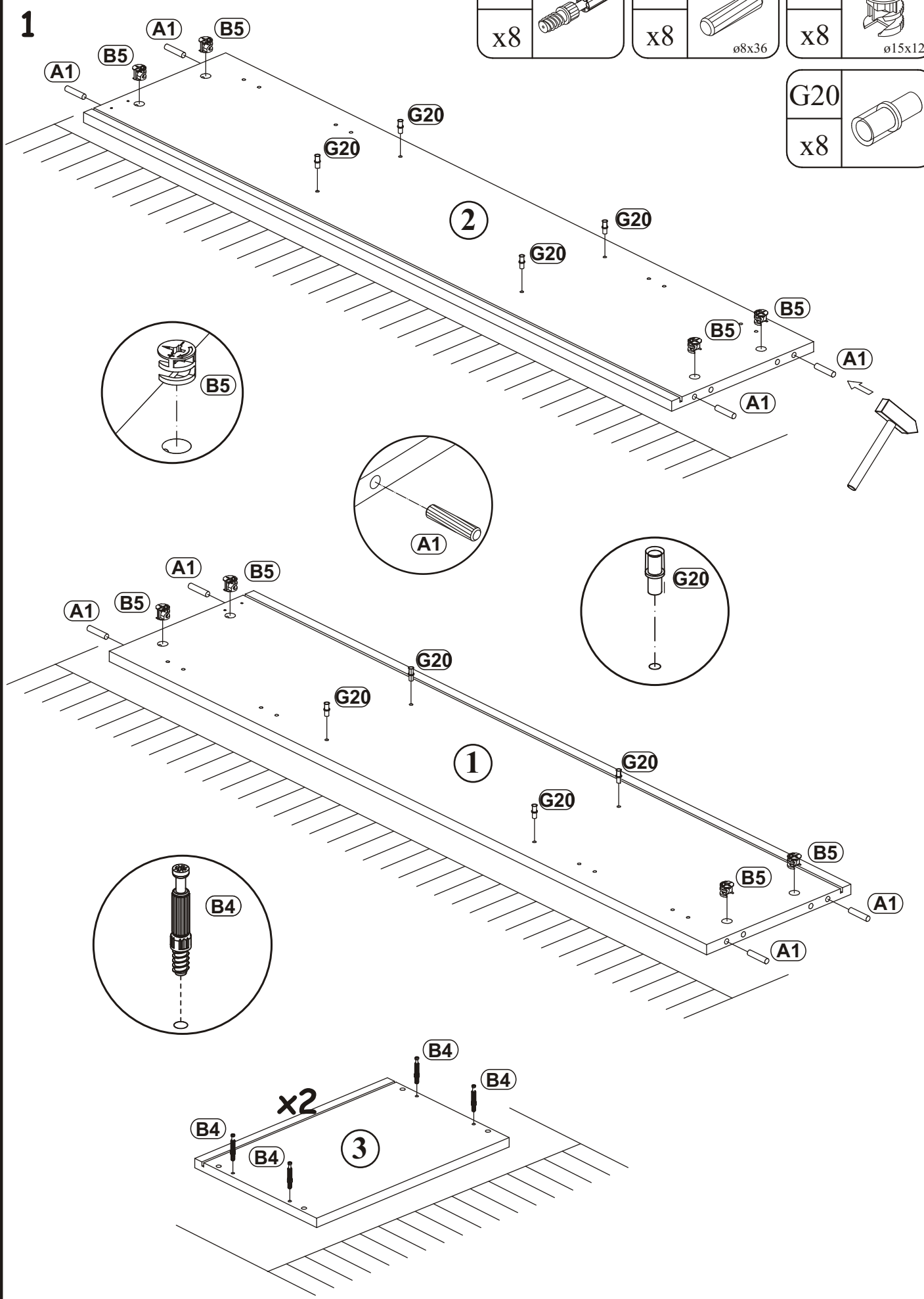

POINT TYP-21

2

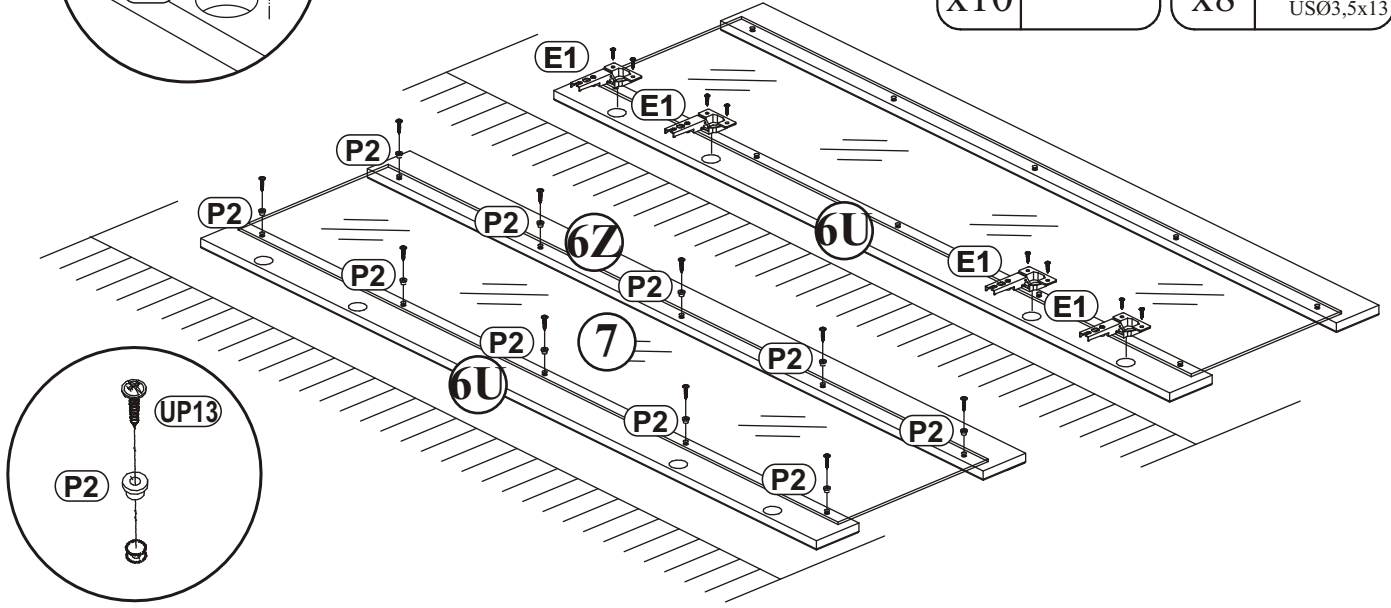
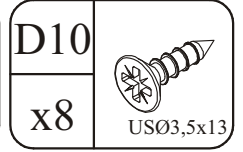
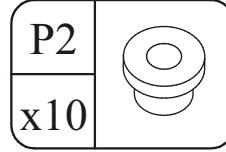
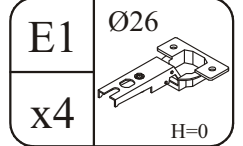
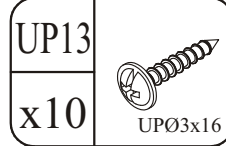
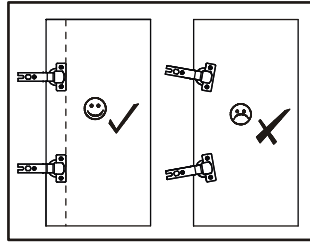
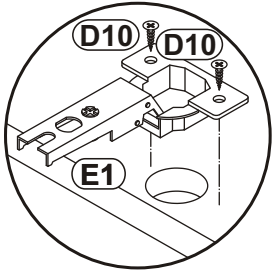

3

a)

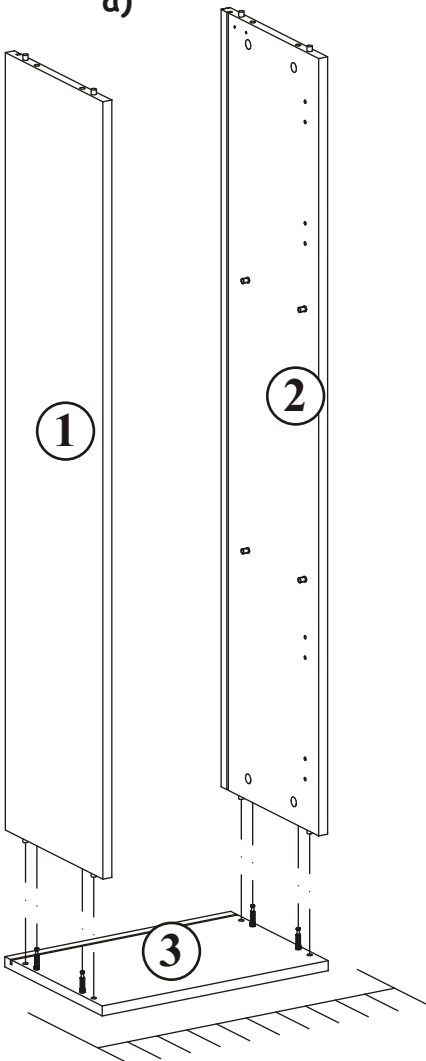

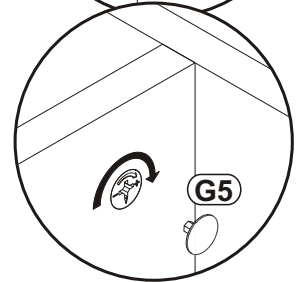
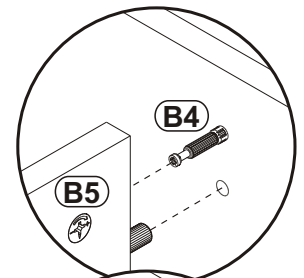
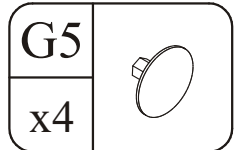
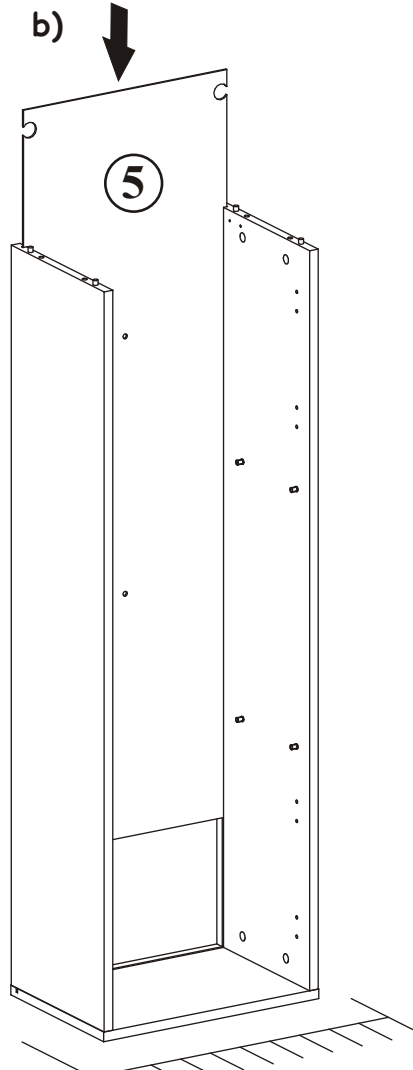

b)

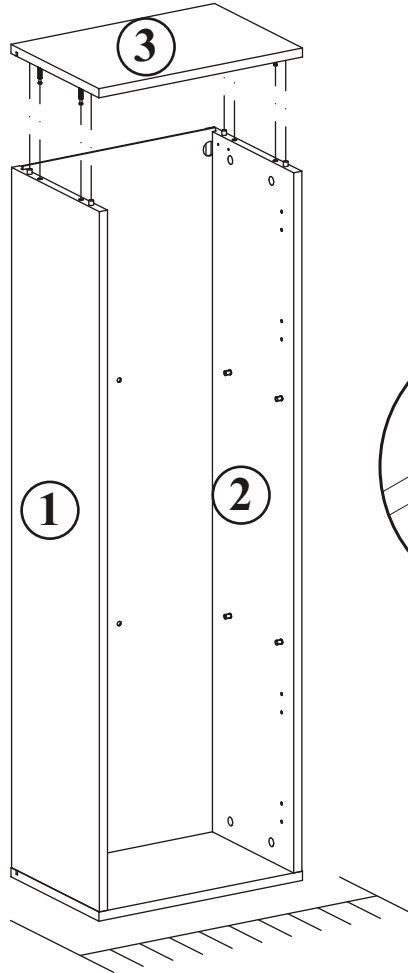

POINT TYP-21

4



G5	
x4	

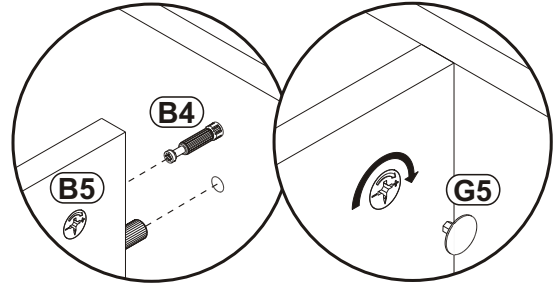

5

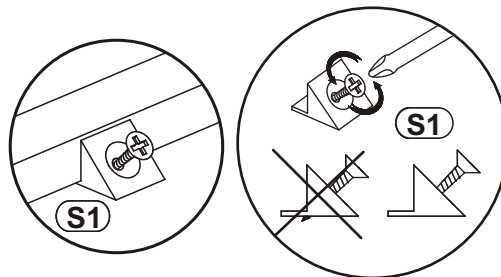

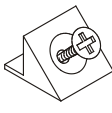
S1	
x10	

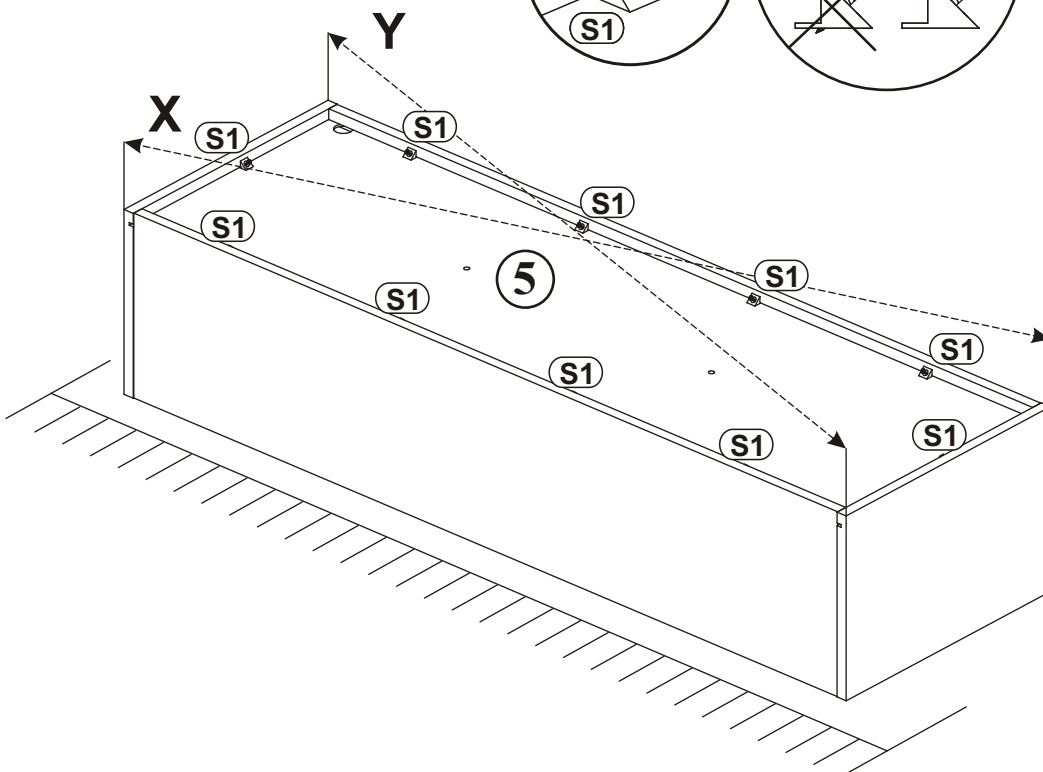

POINT TYP-21

6

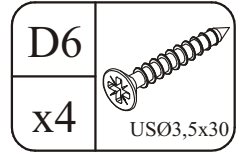
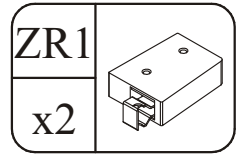
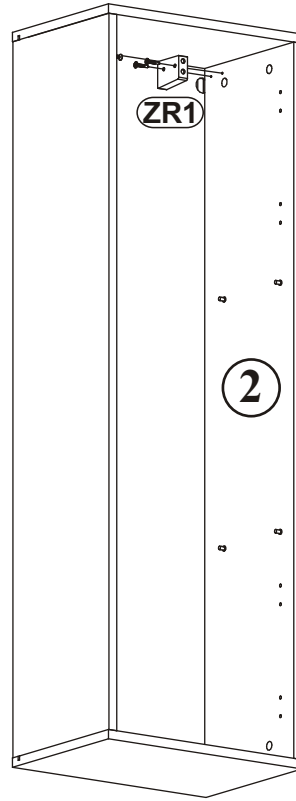
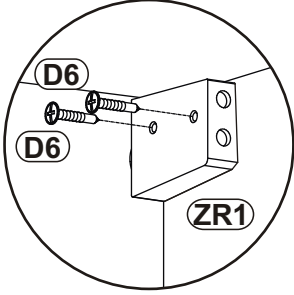
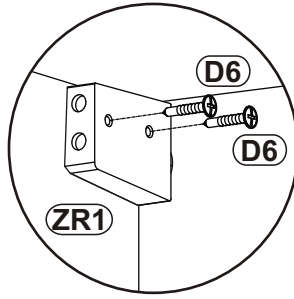
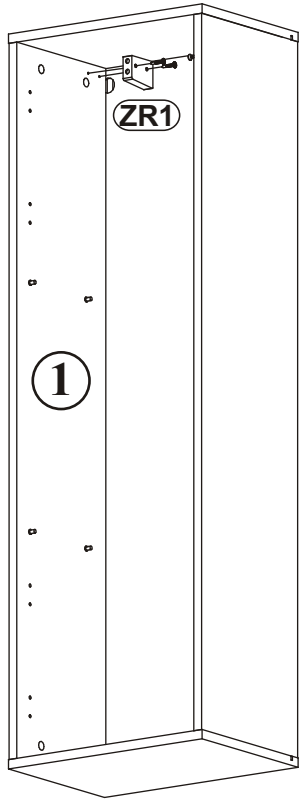

7

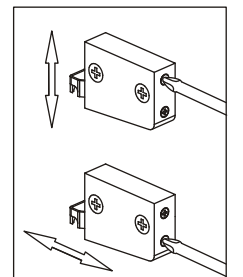
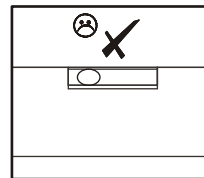
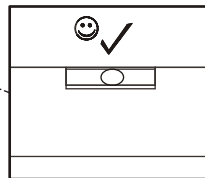
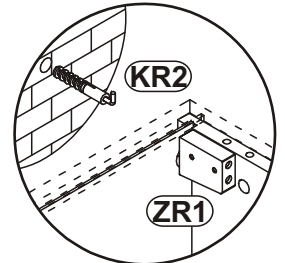
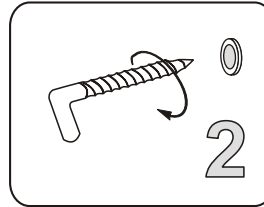
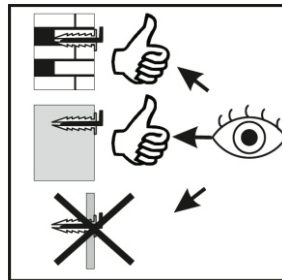
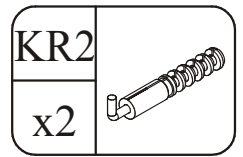
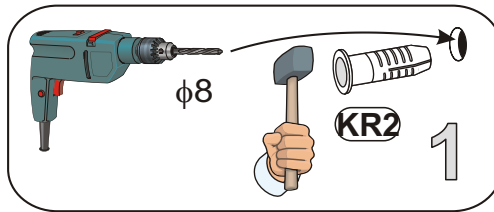
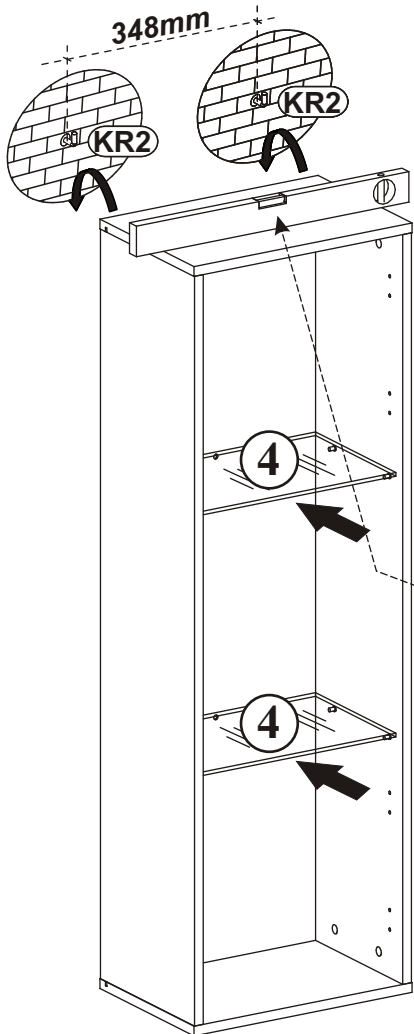

8 - 9

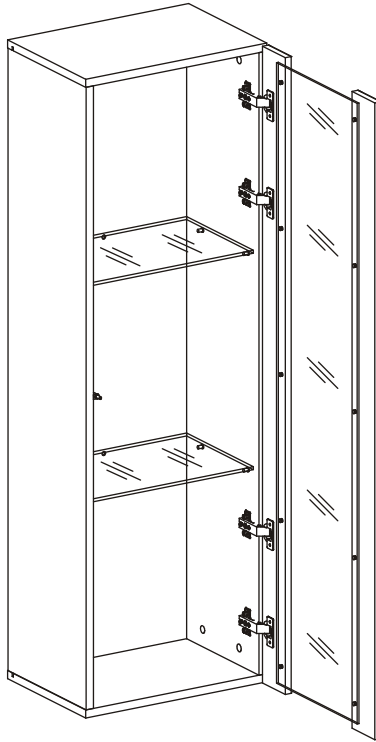

10 - 11

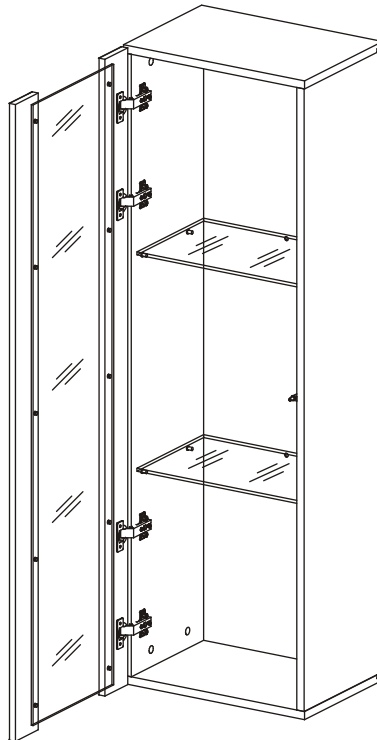

POINT TYP-21

8

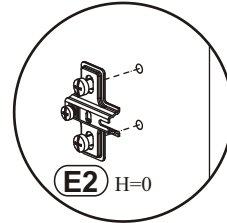
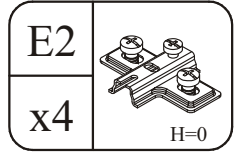
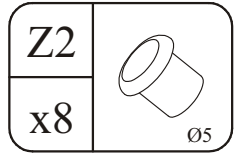
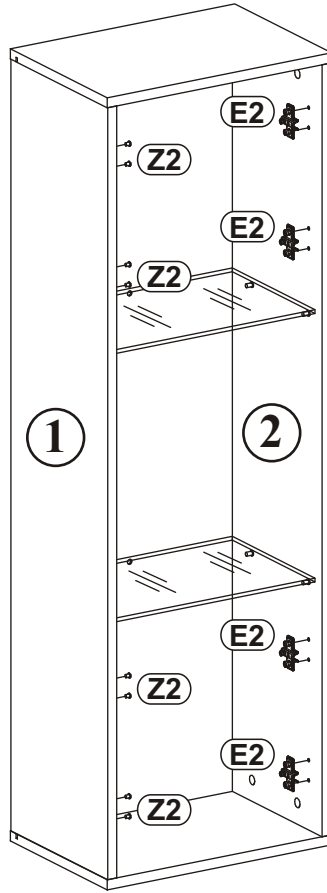
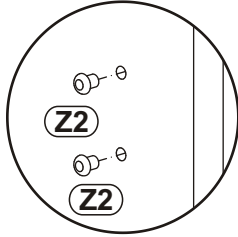
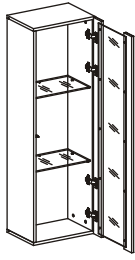

9

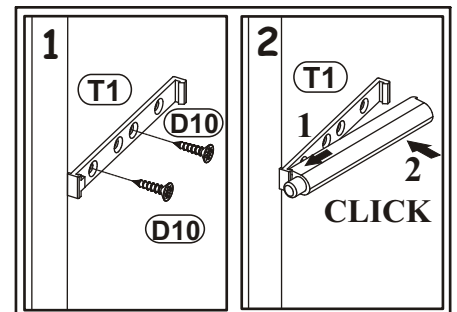
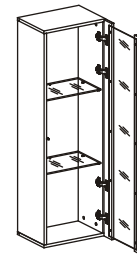
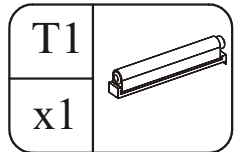
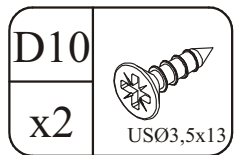
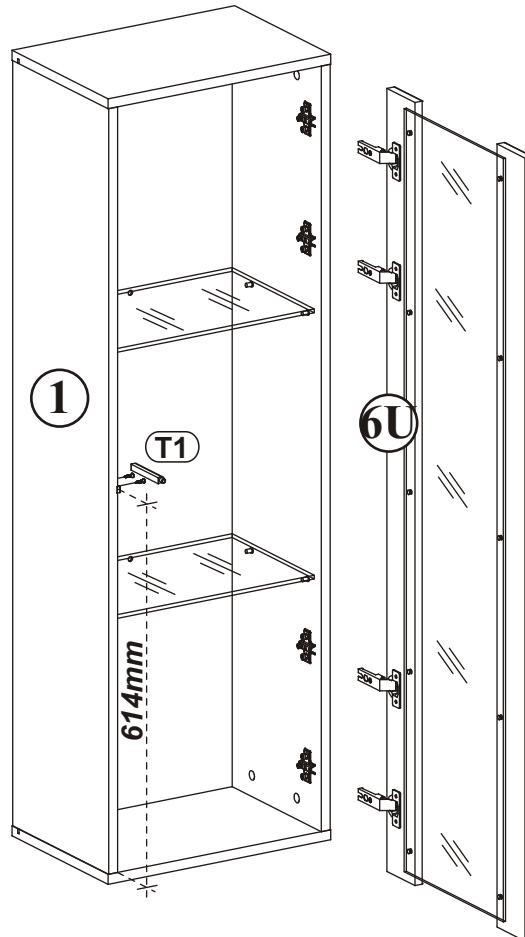
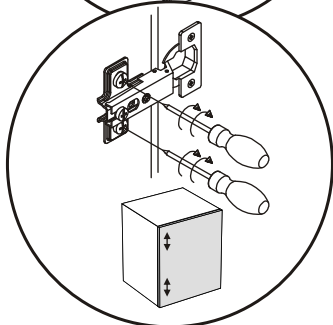
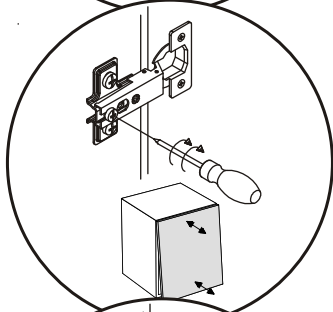
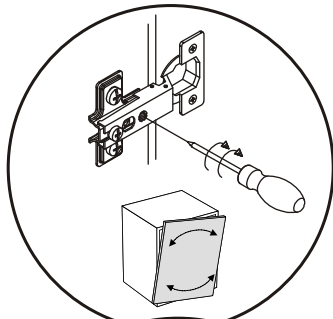

POINT TYP-21

10

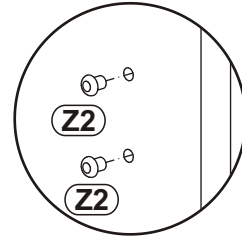
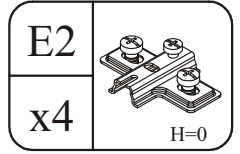
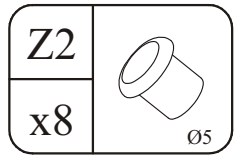
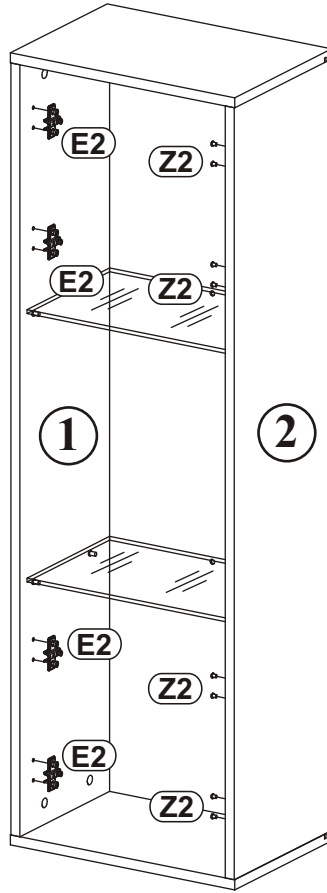
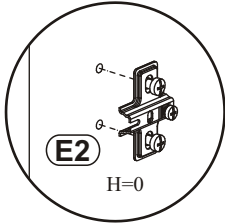
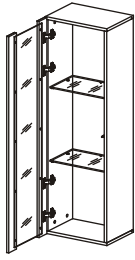

11

